

Essentials

DENTAL

www.ustomed.de

High-Quality Dental and Surgical Instruments
for Dentists, Oral-Maxillofacial Surgeons,
Implantologists, Periodontists and Orthodontists.



Competence in Instruments
MADE IN GERMANY

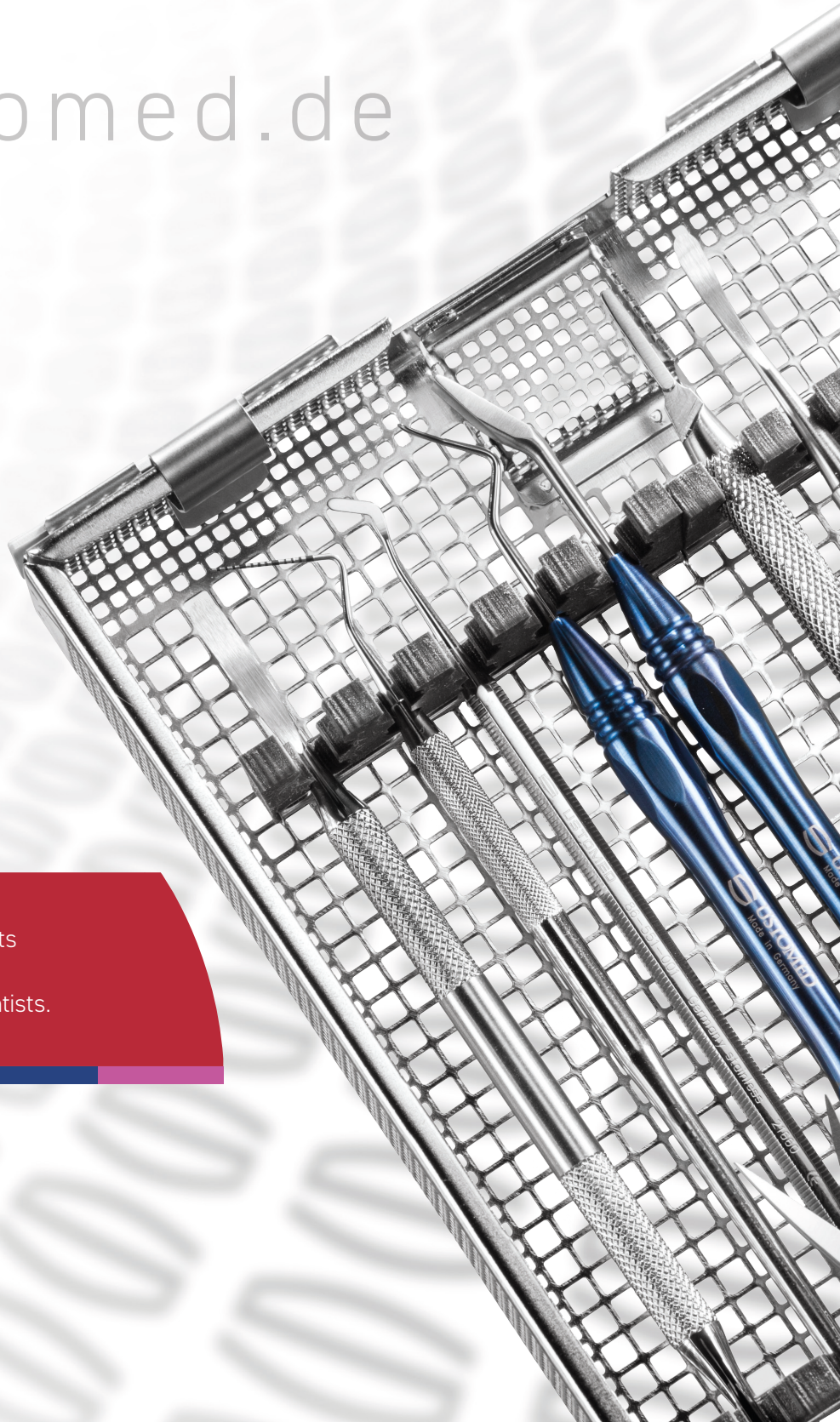

Skilled and experienced surgical
mechanics create top-quality instruments

MADE BY HAND

Technical Competence
with a long Family Tradition

Using selected raw materials and highly advanced machinery

FOR USE BY HAND

Quality that you can see and feel

Many different instruments developed in close collaboration with
internationally renowned universities and opinion leaders



Member of the German Dental Manu-
facturers (VDDI)



Certified by DQS according to:
DIN EN ISO 13485
MDSAP



Competence in Instruments
MADE IN GERMANY



USTOMED:

Dental Instruments from Tuttlingen, the world-wide most important cluster for medical technology. USTOMED develops, designs, produces and distributes instruments for Dentists and , Oral-Maxillofacial Surgeons.

Keeping up-to-date:

A vast network and cooperations with internationally-known operators, universities and Key Opinion Leaders enables us to see new methods and standards earlier and react with developing solutions immediately.

You will profit from long-term experiences, excellent customer service and an incredible competence in the fields of instrument maintenance, sterilization and organization.

3 Great Reasons

USTOMED Instruments was founded over 45 years ago!

Our portfolio contains over **2.500 Products** for different fields in dentistry.

We have already equipped over **3.500 dental offices** world-wide!





USTOMED - CATERING & LOBBY



USTOMED - EDUCATION

ADVANCED-EDUCATION-OFFICE

The affiliated dental office, focusing on Implantology and Periodontology, enables the perfect symbiosis of research, advanced education and the practical development of products. In cooperation with well-known international opinion leaders and implant companies, numerous training events are held every year.



01	<i>SCALPELS AND PERIOTOMES</i>	P.	7-10
02	<i>SCISSORS</i>	P.	11-18
03	<i>MICRO-INSTRUMENTS</i>	P.	19-28
04	<i>TWEEZERS</i>	P.	29-36
03	<i>NEEDLE HOLDERS</i>	P.	37-46
06	<i>WOUND AND CHEEK RETRACTORS</i>	P.	47-58
07	<i>ELEVATORS</i>	P.	59-62
08	<i>SUCTION TUBES AND MEASURING INSTRUMENTS</i>	P.	63-66
09	<i>SINUS CURETTES</i>	P.	67-70
10	<i>AUGMENTATION</i>	P.	71-96
11	<i>ROOT ELEVATORS, LUXATORS AND DESMOTOMES</i>	P.	97-102
12	<i>INSTRUMENTS SETS</i>	P.	103-104
13	<i>CONTAINER SYSTEMS AND WASH TRAYS</i>	P.	105-111

01

SCALPELS AND PERIOTOMES



01

Scalpels and Periotomes

INFO:

Also available with
a smooth handle
02-030-150 G



1/1

02-030-030

Blade Holder, No. 3

125mm



1/1

02-030-150

Blade Holder, round-shaped

150mm



02-040-010

Scalpel Blades Fig. 10
sterile, 100 pcs.



02-040-011

Scalpel Blades Fig. 11
sterile, 100 pcs.



02-040-012

Scalpel Blades Fig. 12
sterile, 100 pcs.



02-040-015

Scalpel Blades Fig. 15
sterile, 100 pcs.



02-040-124

Scalpel Blades Fig. 12d
sterile, 100 pcs.



02-040-153

Scalpel Blades Fig. 15c
sterile, 100 pcs.

INFO:
for standard blades



1/1

85-817-360
Universal-Blade Holder,
turnable
165mm



1/1

02-038-140
Micro-Blade holder,
ergon. grip
140mm



02-044-063
Micro-Blades
Fig. 63
sterile, 25 pcs.



02-044-067
Micro-Blades
Fig. 67
sterile, 25 pcs.



02-044-069
Micro-Blades
Fig. 69
sterile, 25 pcs.



02-042-069
Super-Micro-Blades
Fig. 69, bendable
sterile, 6 pcs.

01

Scalpels and Periotomes



02-790-000

Periotome, Fig. 1, complete

170mm



02-791-000

Periotome, Fig. 2, complete

140mm



02-790-001

Periotome Blade, only
Fig. 1, straight

1/1



02-791-001

Periotome Blade, only
Fig. 2, angled

1/1

02

SCISSORS



02 Scissors

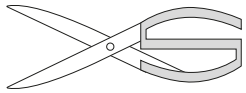

STANDARD:

Standard Cut

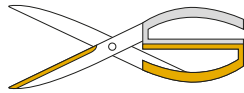

SUPERCUT (SC):

Special Cut with toothing in one scissor blade in order to prevent sliding of gum and suture material

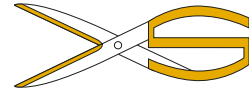

TUNGSTEN CARBIDE (TC):

Special Hard-Metal Inlays increasing life time and sharpness, of the Instrument



1/1

METZENBAUM
dissect. Scissors, straight



1/1

METZENBAUM DELICAT
dissect. Scissors, straight



1/1

REYNOLDS
dissect. Scissors, curved



03-070-145
145mm Standard



03-070-145 SC
145mm Supercut



04-320-145
145mm TC



03-080-145
145mm Standard



03-080-145 SC
145mm Supercut



04-322-145
145mm TC



03-155-145
145mm Standard

Scissors 02



METZENBAUM
dissect. Scissors, curved

METZENBAUM DELICAT
dissect. Scissors, curved

JAMESON
dissect. Scissors, curved

 03-071-145
145mm Standard

 03-081-145
145mm Standard

 03-185-155
155mm Standard

 03-071-145 SC
145mm Supercut

 03-081-145 SC
145mm Supercut

 04-325-145
145mm TC

 04-327-145
145mm TC

02

Scissors





KELLY
Gum and Suture Scissors

KELLY
Gum and Suture Scissors

KELLY
Gum and Suture Scissors

 03-630-160
160mm, straight.

 03-631-160
160mm, curved

 03-631-180
180mm, curved

 03-630-180
180mm, straight.

 03-631-160 SC
160mm, curved, Supercut

 03-631-180 SC
180mm, curved, Supercut



1/1

JOSEPH
Gum and Suture Scissors



03-440-140
140mm, straight.



03-440-140 SC
140mm, straight, Supercut



1/1

JOSEPH
Gum and Suture Scissors



03-441-140
140mm, curved



03-441-140 SC
140mm, curved, Supercut



1/1

JOSEPH
Gum and Suture Scissors



04-441-140
140mm, curved, TC



04-440-140
140mm, straight, TC

02 Scissors

INFO:

The fine tips give these scissor blades a very slender shape and allow an optimal view of the operating environment. The toothed cutting blades are particular suitable for cutting sutures.

extra large rings





Fox
Gum and Suture Scissors

Fox
Gum and Suture Scissors

Gum and Suture Scissors

 03-420-130
130mm, smooth, straight.

 03-421-130
130mm, smooth, curved.

 03-327-130
130mm, curved.

 03-412-130
130mm, toothed, straight.

 03-417-130
130mm, toothed, curved.

 03-327-130 SC
130mm, curved., Supercut

 04-420-130
130mm, straight., TC

 03-417-130 SC
130mm, curved, Supercut.



 04-421-130
130mm, curved., TC



LA GRANGE
Gum and Suture Scissors



Gum and Suture Scissors

Gum and Suture Scissors

-  03-401-105
115mm
-  03-401-105 SC
115mm, Supercut

-  03-320-115
115mm, straight
-  03-320-115 SC
115mm, straight, Supercut

-  04-520-115
115mm, straight, TC

-  03-321-115
115mm, curved
-  03-321-115 SC
115mm, curved, Supercut

-  04-521-115
115mm, curved, TC

02

Scissors



SPENCER
Ligature Scissors

 03-720-090
90mm

 03-720-130
130mm



BEEBEE
Wire/Plate Scissors

 03-744-105
105mm, straight, sharp tip

 03-746-105
105mm, straight, toothed

 03-748-105
105mm, straight, blunt tip



BEEBEE
Wire/Plate Scissors

 03-745-105
105mm, curved, sharp tip

 03-747-105
105mm, curved, toothed

 03-749-105
105mm, curved, blunt tip

03

MICRO-INSTRUMENTS



03

Micro-Instruments

INFO:

The round-shaped handle enables a much easier twisting of the instrument in the hand.



1/1

WESTCOTT
Gum Scissors

05-045-115
115mm, curved

05-149-110
110mm, sharp tip

05-151-110
110mm, blunt tip



1/1

USTOMED
Gum and Sture Scissors

05-621-145
145mm, straight, sharp tip



1/1

BARRAQUER
Micro-Scissors

05-809-145
145mm, curved, round handles

05-809-180
180mm, curved, round handles



INFO:
 The very slim and curved cutting edges are particularly well suited for the de-epithelialization and connective-tissue corrections.



INFO:
 The additionally rounded Cooley grip enables a very atraumatic holding of the tissue.



approx.. 0,6mm

INFO:
 The ultra-fine diamond-coated tips enables a pinpoint thread of the suture needles.
 Ideal for suture material from 5.0-8.0.
 The specially-rounded edges of the tips prevent suture materials from tearing at the knot.

USTOMED I'MOTION Micro-Scissors

05-803-180
180mm

USTOMED I'MOTION Micro-Tweezers

09-280-180
180mm, straight,
Cooley-grip

 USTOMED I'MOTION Micro-Needle Holder

20-752-180
180mm, straight, diamond-coated tips
20-753-180
180mm, curved, diamond-coated tips

03

Micro-Instruments

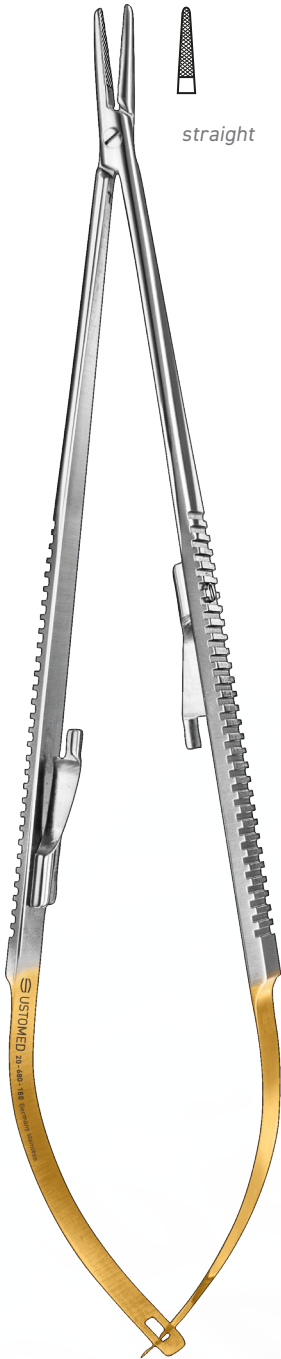

straight

1/1



CASTROVIEJO
Micro-Needle Holder TC

20-680-180
180mm, straight

20-681-180
180mm, curved

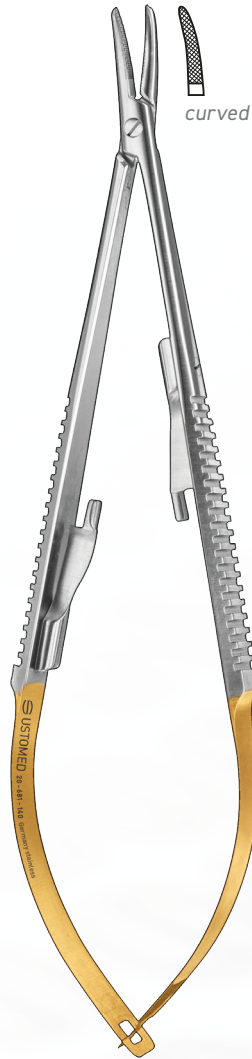

curved

1/1



CASTROVIEJO
Micro-Needle Holder TC

20-680-140
140mm, straight

20-681-140
140mm, curved



1/1



1/1

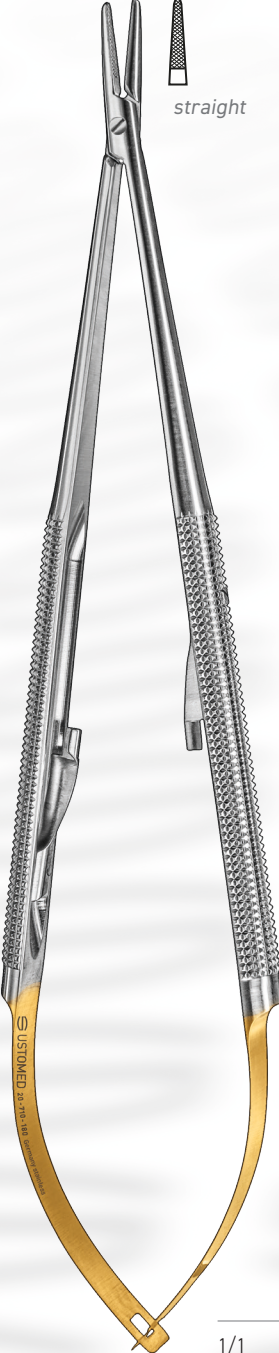

1/1

 **CASTROVIEJO**
Micro-Needle Holder TC

- 20-722-130
130mm
- 20-722-160
160mm
- 20-722-180
180mm

 **BARRAQUER**
Micro-Needle Holder TC

- 20-710-140
140mm, straight
- 20-711-140
140mm, curved

 **BARRAQUER**
Micro-Needle Holder TC

- 20-710-180
180mm, straight
- 20-711-180
180mm, curved

03

Micro-Instruments



1/1

INFO:
Perfect for holding suture materials

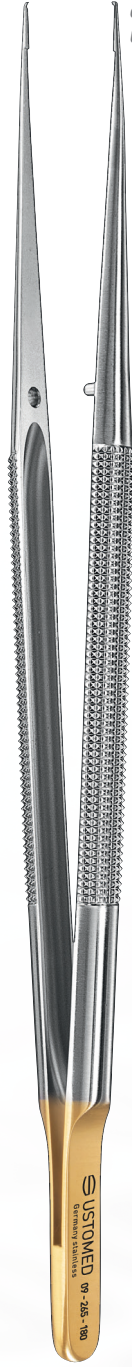

1/1

curved version
09-267-180

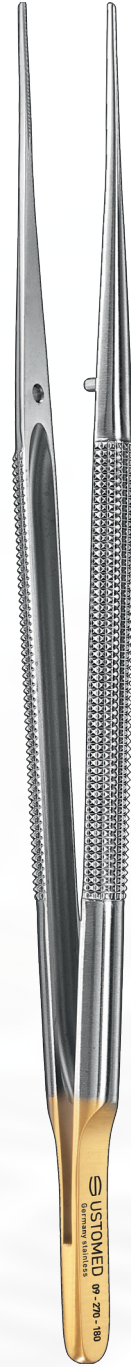

1/1

 highly magnified



USTOMED
Micro-Tweezers

09-230-180
anatomical,
diamond-coated
180mm

USTOMED
Micro-Tweezers

09-265-180
surgical
180mm

DEBAKEY
Micro-Tweezers

09-270-180
atraumatic
180mm



CARBON-COATING

The special plasma-carbon coating increases the surface-durability of the working tips and ensures a glare-free work under the microscope.



USTO-SOFT GRIFF
Papillae Elevator

85-812-000
atraumatic
175mm

USTOMED
Papillae Elevator

85-812-175
atraumatic
175mm



ZUCHELLI
Papillae Elevator

85-814-175
175mm

03

Micro-Instruments



NORTH-CAROLINA
Perio Probe
85-691-115
CP15, Probe
190mm



USTO-SOFT GRIIP
Perio Dissector
85-808-000
Mod.W.
185mm



USTOMED
Perio Dissector
85-808-175
Mod.W.
170mm



 **KASAJ**
Tunneling Knife.
85-818-001
200mm



 **KASAJ**
Tunneling Knife.
85-818-002
190mm



 **MODELL-B.**
Tunneling Knife.
85-816-170
Micro B.
170mm

03

Micro-Instruments



1/1

USTO-SOFT GRIP
Raspatory

85-816-000
Mod.B.
175mm



1/1

USTOMED
Raspatory

85-816-175
Mod.B.
175mm



1/1

USTOMED
Tunneling Knife

85-818-175
175mm

04

TWEEZERS



04

Tweezers



USTOMED
Anatomical Tweezers

- 08-036-145
130mm
- 08-036-160
160mm
- 08-036-180
180mm



GERALD
Anatomical Tweezers

- 08-100-175
175mm

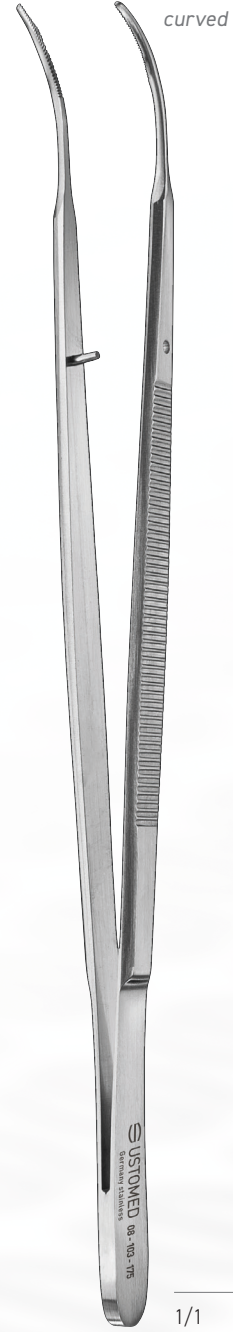

GERALD
Anatomical Tweezers

- 08-103-175
175mm



1/1

COLLEGE
Anatomical Tweezers

- 10-825-150
130mm
- 10-825-160
160mm
- 10-825-180
180mm



diamond-coated

1/1



COLLEGE
Anatomical Tweezers

- 10-827-150
150mm, diamond-coated

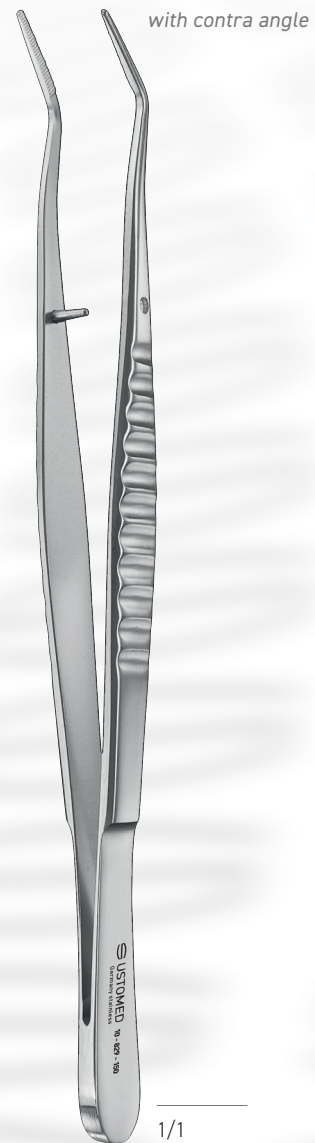

with contra angle

1/1

COLLEGE
Anatomical Tweezers

- 10-829-150
150mm, with contra angle

04

Tweezers

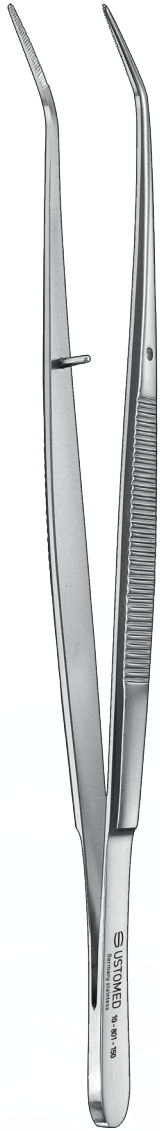

1/1

COLLEGE
Tweezers

10-801-150
150mm, anatomical

10-803-150
150mm, plain



1/1

MERIAM
Tweezers

10-841-160
160mm, grooved

10-843-160
160mm plain



1/1

MERIAM
Tweezers

10-845-155
155mm, modified

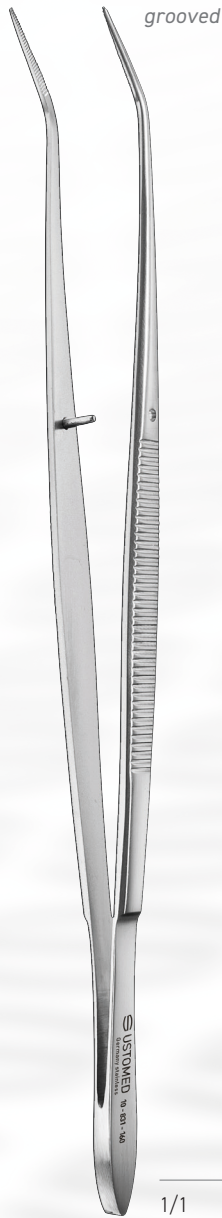

FLAGG
Tweezers

10-831-160
160mm, grooved

10-833-160
160mm, plain



GERALD
Surgical Tweezers

08-301-175
175mm, straight

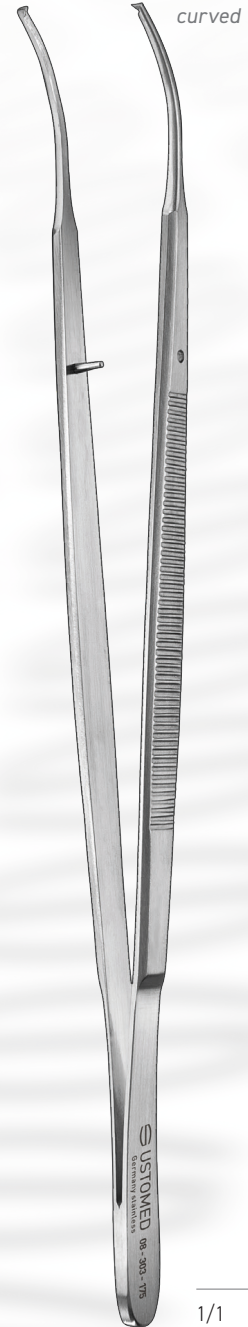

GERALD
Surgical Tweezers

08-303-175
175mm, curved

04

Tweezers



1/1

Surgical Tweezers

08-235-145
145mm, delicate

08-235-160
160mm, delicate

08-235-180
180mm, delicate

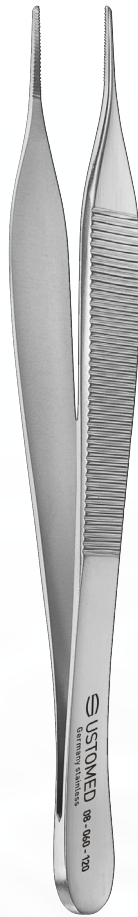

1/1

ADSON Tweezers

08-060-120
120mm, anatomical

08-261-120
120mm, surgical



1/1

USTOMED I'MOTION COOLEY Micro-Tweezers

09-280-180
180mm, atraumatic,
Cooley-grip

INFO

More Details
on page 21



INFO:
Perfect for holding suture materials

1/1

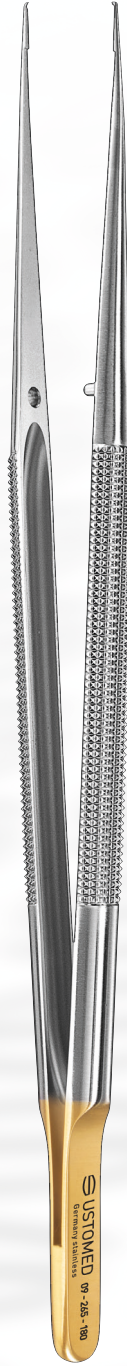

curved version possible

1/1

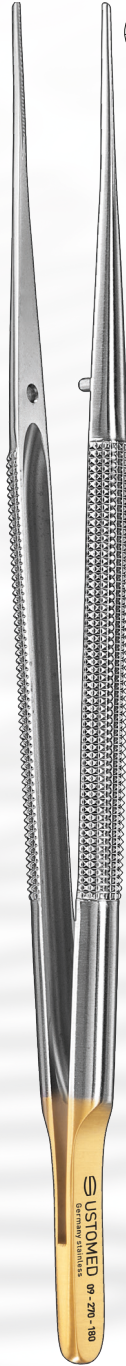

highly magnified

1/1



USTOMED
Micro-Tweezers

09-230-180
180mm, anatomical,
diamond-coated

USTOMED
Micro-Tweezers

09-265-180
180mm, surgical, straight

09-267-180
180mm, surgical, curved

DeBAKEY
Micro-Tweezers

09-270-180
180mm, atraumatic

04

Tweezers

Photo Copyright Dr. Ponte

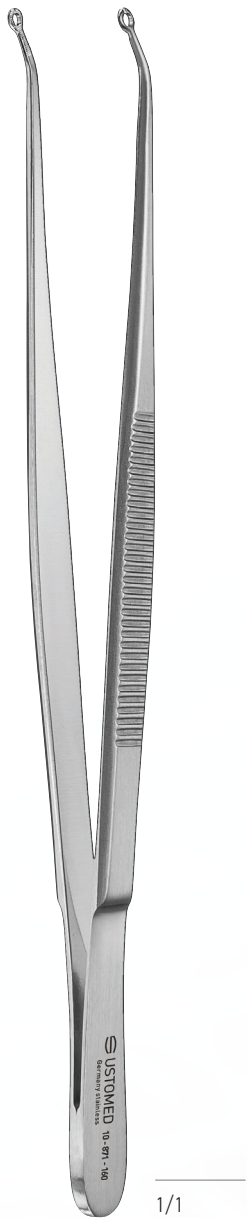
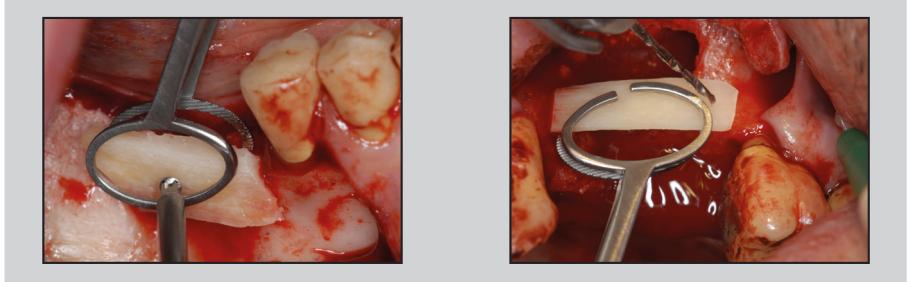

1/1

Graft Tweezers
with opening for sutures

10-871-160
160mm



1/1

PONTE
Bone Block Tweezers

10-875-160
160mm
standard



1/1

PONTE
Bone Block Tweezers

10-877-160
180mm
small

05

NEEDLE HOLDERS



05

Needle Holders

INFO

Overview on suture material sizes per Needle Holder on page 46.



 **HALSEY**
Needle Holder TC

20-120-130
130mm



 **BABY-CRILE-WOOD**
Needle Holder TC

20-160-150
150mm



CRILE-WOOD
Needle Holder TC

20-164-150
150mm

20-164-180
180mm

20-164-205
205mm

05

Needle Holders



MAYO-HEGAR
Needle Holder TC

20-220-160
160mm

20-220-180
180mm

20-220-200
200mm



MICRO-RYDER
Needle Holder TC

20-320-130
130mm

20-320-150
150mm

20-320-180
180mm



1/1



1/1



LANGENBECK
Needle Holder TC

20-392-160
160mm

20-392-180
180mm

20-392-200
200mm



TOENNIS
Needle Holder TC

20-398-180
180mm

05

Needle Holders



INFO:
The inwards-bended lock prevents the glove from pinching.



MATHIEU
Needle Holder TC

20-452-140
140mm

20-452-170
170mm

20-452-200
200mm



LICHTENBERG
Needle Holder TC

20-470-170
170mm



INFO
More details on page 21.



USTOMED I'MOTION
Micro-Needle Holder

20-752-180
180mm, diamond-coated, straight

20-753-180
180mm, diamond-coated, curved



CASTROVIEJO
Needle Holder TC

20-722-130
130mm

20-722-160
160mm

20-722-180
180mm

05

Needle Holders

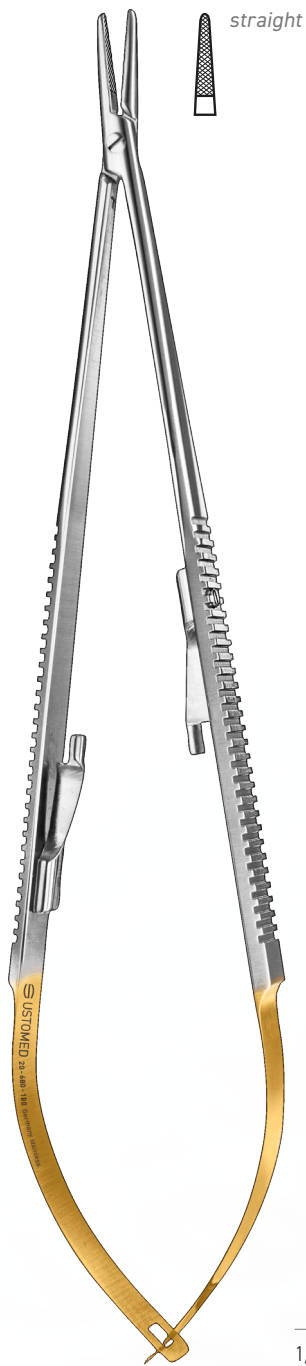

CASTROVIEJO
Micro-Needle Holder TC

20-680-140
140mm, straight

20-680-180
180mm, curved

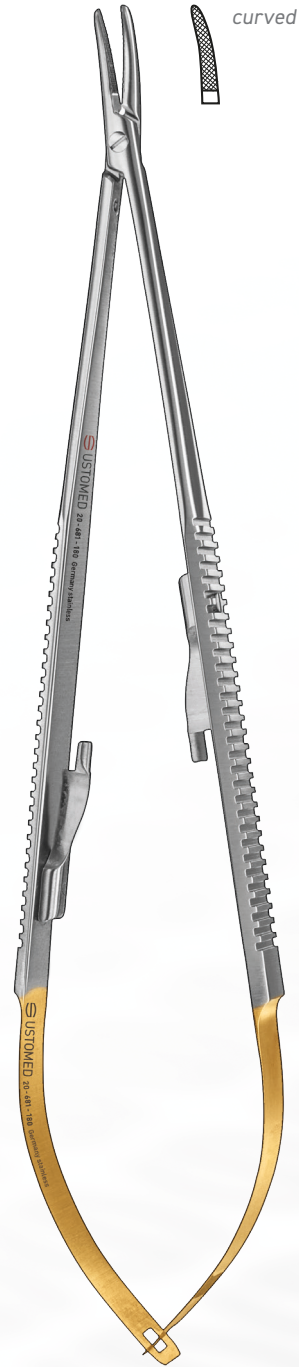

CASTROVIEJO
Micro-Needle Holder TC

20-681-140
140mm, curved

20-681-180
180mm, curved

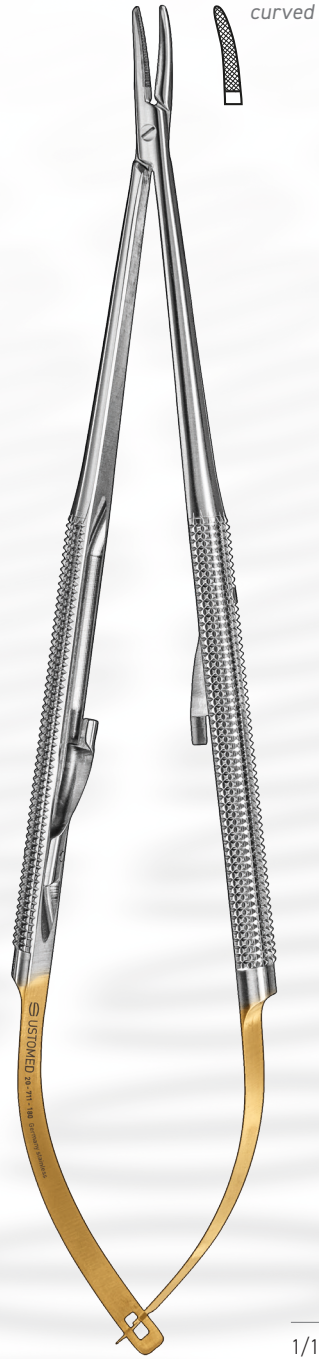
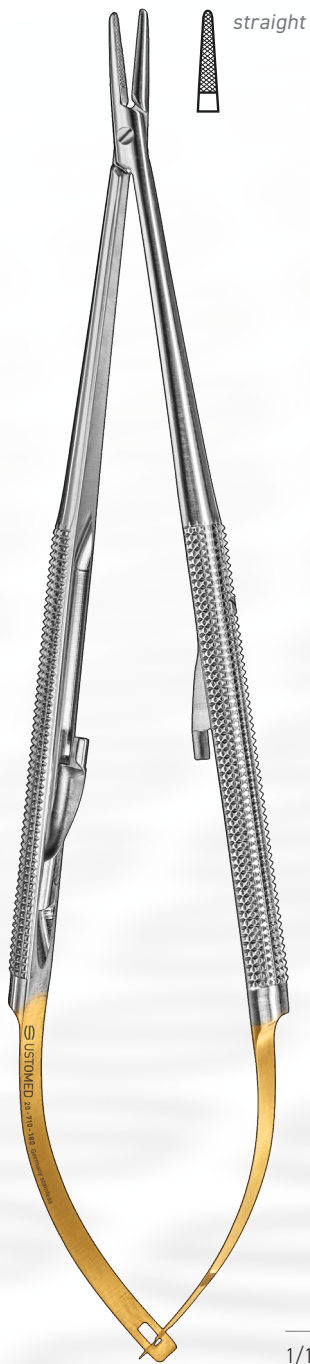

BARRAQUER
Micro-Needle Holder TC

20-710-140
140mm, straight

20-710-180
180mm, curved



BARRAQUER
Micro-Needle Holder TC

20-711-140
140mm, curved

20-711-180
180mm, curved

05

Needle Holders

Matrix - Needle Holders and Suture Material Sizes:

	3/0	4/0	5/0	6/0	7/0	8/0
20-120-130	✓	✓	✓	✗	✗	✗
20-160-150	✗	✓	✓	✗	✗	✗
20-164-150	✓	✓	✓	✗	✗	✗
20-164-180	✓	✓	✓	✗	✗	✗
20-164-205	✓	✓	✓	✗	✗	✗
20-220-160	✓	✓	✗	✗	✗	✗
20-220-180	✓	✓	✗	✗	✗	✗
20-220-200	✓	✓	✗	✗	✗	✗
20-320-130	✗	✗	✓	✓	✗	✗
20-320-150	✗	✗	✓	✓	✗	✗
20-320-180	✗	✗	✓	✓	✗	✗
20-392-160	✓	✓	✓	✗	✗	✗
20-392-180	✓	✓	✓	✗	✗	✗
20-392-200	✓	✓	✗	✗	✗	✗
20-398-180	✓	✓	✗	✗	✗	✗
20-452-140	✓	✓	✗	✗	✗	✗
20-452-170	✓	✓	✗	✗	✗	✗
20-452-200	✓	✓	✗	✗	✗	✗
20-470-170	✓	✓	✗	✗	✗	✗
20-680-140	✗	✗	✓	✓	✓	✗
20-681-140	✗	✗	✓	✓	✓	✗
20-680-180	✗	✗	✓	✓	✓	✗
20-681-180	✗	✗	✓	✓	✓	✗
20-710-140	✗	✗	✓	✓	✓	✗
20-711-140	✗	✗	✓	✓	✓	✗
20-710-180	✗	✗	✓	✓	✓	✗
20-711-180	✗	✗	✓	✓	✓	✗
20-722-130	✗	✗	✓	✓	✓	✗
20-722-160	✗	✗	✓	✓	✓	✗
20-722-180	✗	✓	✓	✓	✗	✗
20-752-180	✗	✗	✓	✓	✓	✓
20-753-180	✗	✗	✓	✓	✓	✓

06

WOUND AND CHEEK RETRACTORS



06

Wound/Cheek Retractors



KILNER
Tissue Retractor

24-421-150

150mm



Fig. 1

GILLIES
Tissue Retractor

24-425-001

180mm



Fig. 2

GILLIES
Tissue Retractor

24-425-002

180mm



GUTHRIE
Tissue Retractor
24-469-002

130mm



JOSEPH
Tissue Retractor
24-573-002

160mm



06

Wound/Cheek Retractors



Wound Retractor
24-021-001
single fork
160mm



Wound Retractor
24-021-002
dual fork
160mm



Wound Retractor
24-023-001
single fork
160mm



Wound Retractor
24-023-002
dual fork
160mm



Wound Retractor
24-031-002
triple fork
160mm



Wound Retractor
24-033-002
triple fork
160mm

06

Wound/Cheek Retractors



3/4

NENTWIG
Zygomatic Retractor
24-191-230

230mm

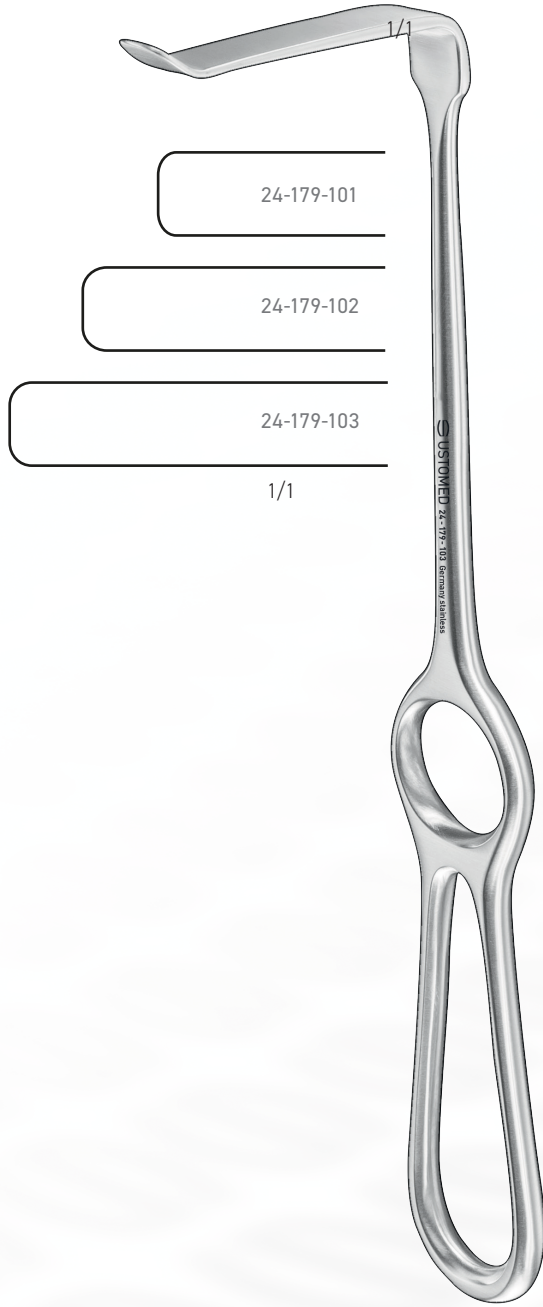

24-179-101

24-179-102

24-179-103

1/1

3/4

KOCHER
Wound Retractor

240mm

Wound/Cheek Retractors

06

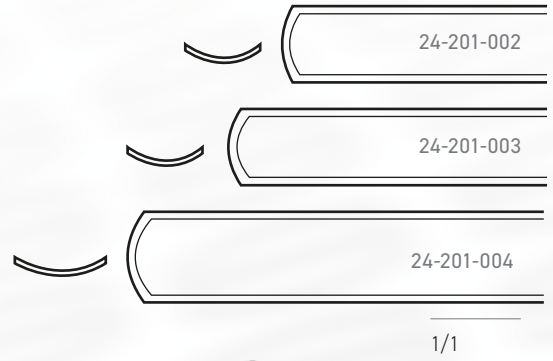
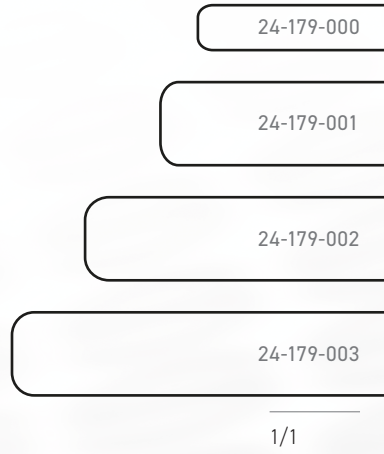
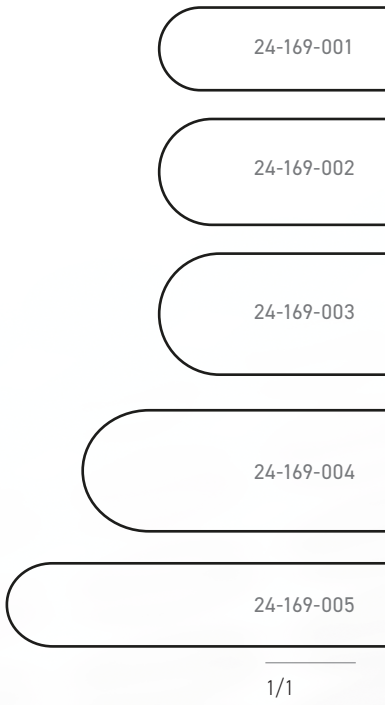

LANGENBECK
Wound Retractor

210mm



KOCHER
Wound Retractor

210mm



OBWEGESER
Wound Retractor

240mm

06

Wound/Cheek Retractors



Silicone-Mouth Wedge
for children

48-091-001

Size 1

Silicone-Mouth Wedge
for adults

48-091-002

Size 2



1/1

USTOMED
Universal Mouth Gag, complete
48-149-000

130mm



for children
only 48-149-001

1/1



for adults
only 48-149-002

1/1

06

Wound/Cheek Retractors



LASTER
Special Wound Retractor
for upper third molars

24-203-105

110mm

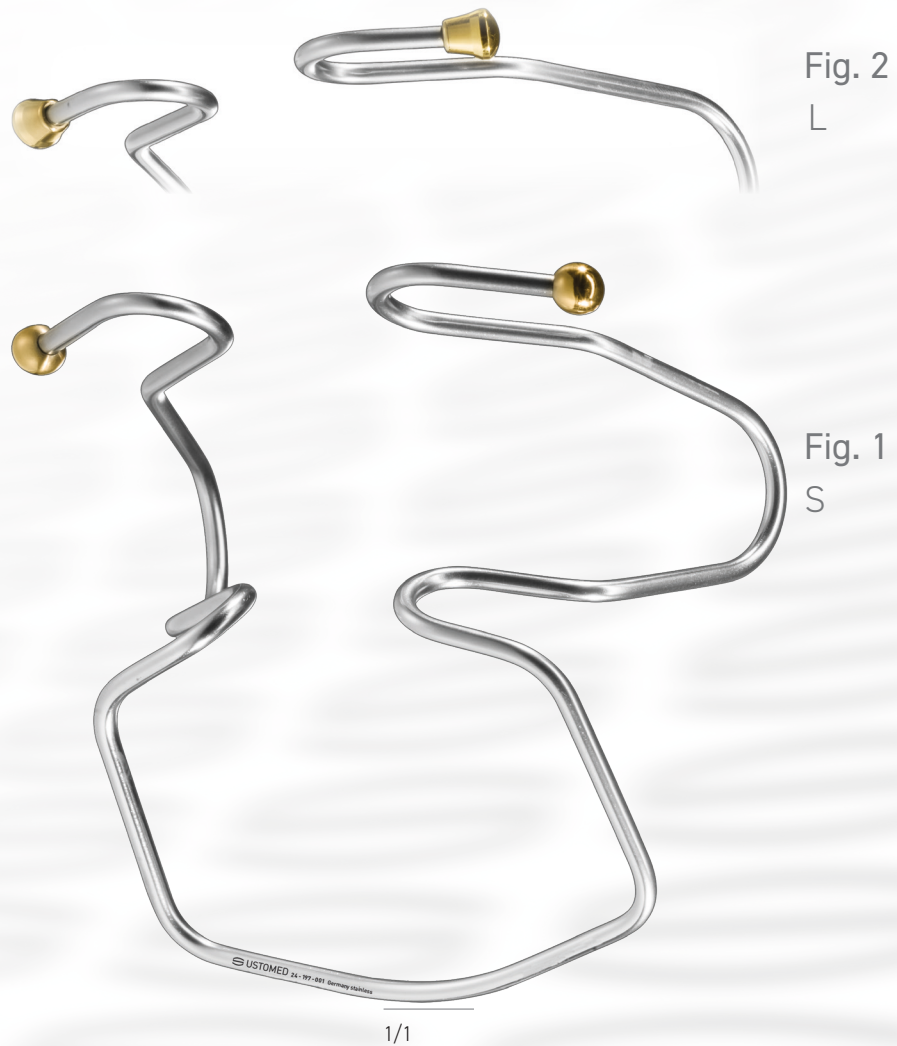

HILGER
Mouth Clamp

24-197-001, Fig. 1
24-197-002, Fig. 2

06

Wound/Cheek Retractors

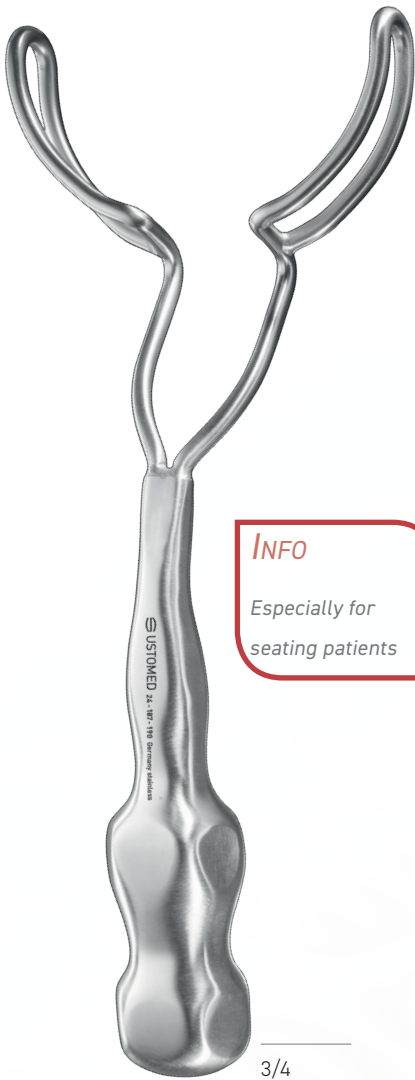
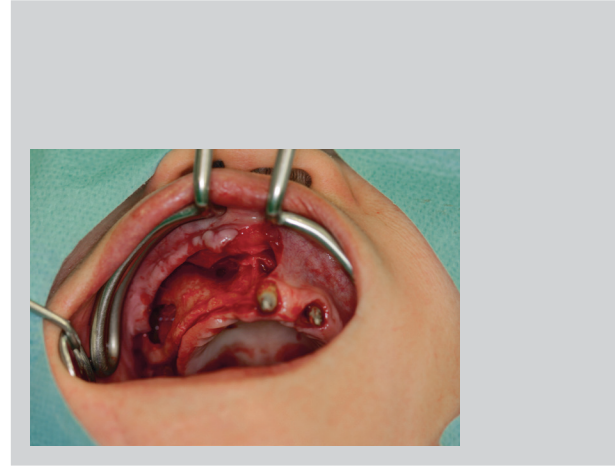

INFO
Especially for
seating patients

USTOMED
Universal Vestibule Retractor
24-187-190
straight
190mm

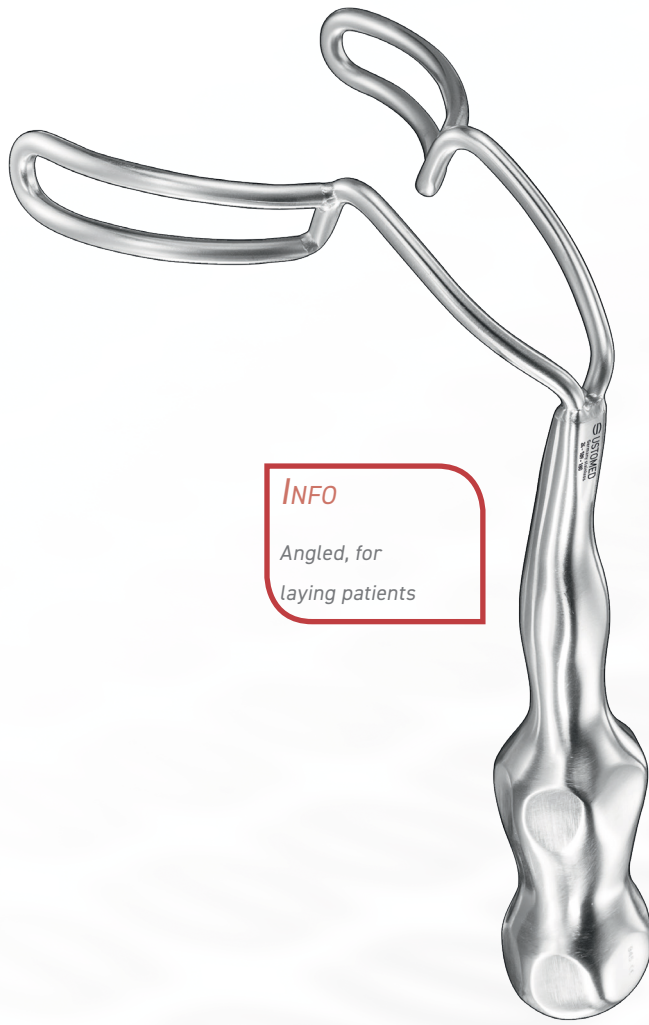

INFO
Angled, for
laying patients

USTOMED
Universal Vestibule Retractor
24-189-180
angled
180mm

07

ELEVATORS AND RASPATORIES



07

Elevators and Raspatories



FREER
Elevator
27-451-180
180mm



PRICHARD
Raspatory
27-459-175
175mm



GLICKMAN
Raspatory
27-711-024
165mm



USTOMED
Raspatory
27-717-175

175mm



WILLIGER
Raspatory
27-741-160

160mm

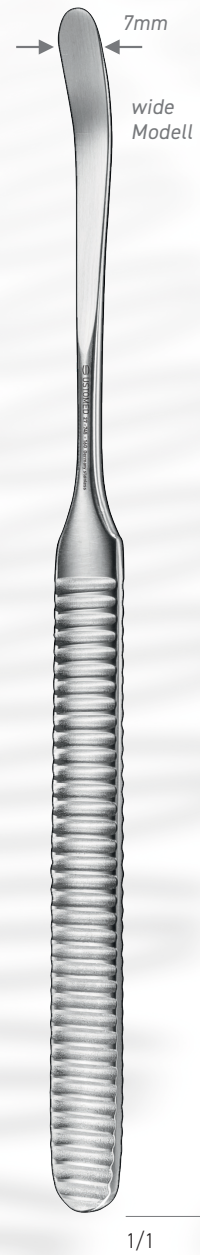

WILLIGER
Raspatory
27-745-160

160mm

07

Elevators and Raspatories



WILLIGER
Raspatory
27-743-130

130mm



OBWEGESER
Raspatory
27-749-006

175mm



7mm
27-749-007



9mm
27-749-009

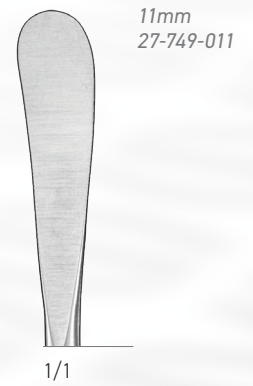

11mm
27-749-011

08

SUCTION TUBES AND MEASURING INSTRUMENTS



08

Suction Tubes and Measuring Instruments



Filters
38-505-003
3 pcs/pack



1/1



Bone Trap
Stainless Suction Attachment
38-505-000

110mm

INFO
1,5mm inner diameter
2,5mm outer diameter



1/1

Suction Tube
38-519-015
metal
180mm

INFO
with Luer lock

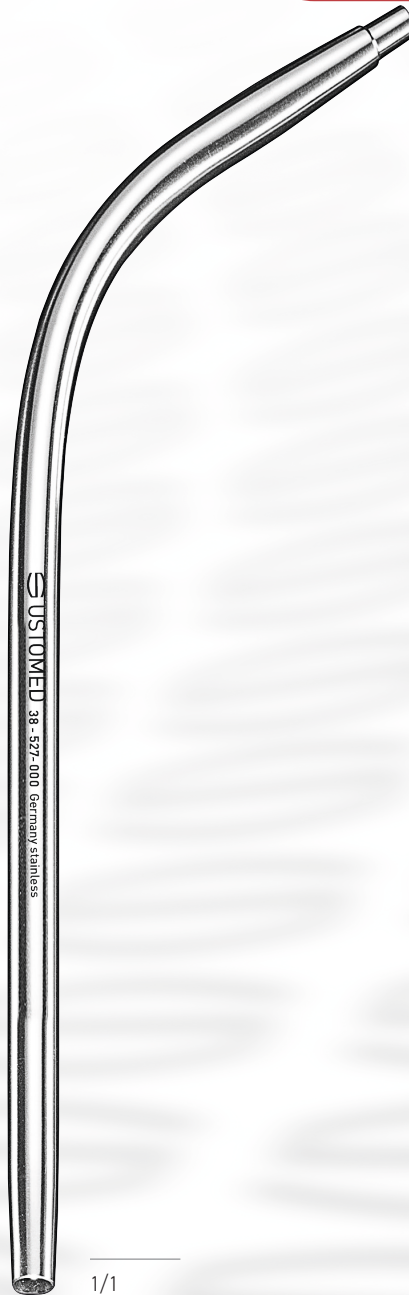

1/1

KHOURY
Suction Tube
38-527-000
metal
170mm

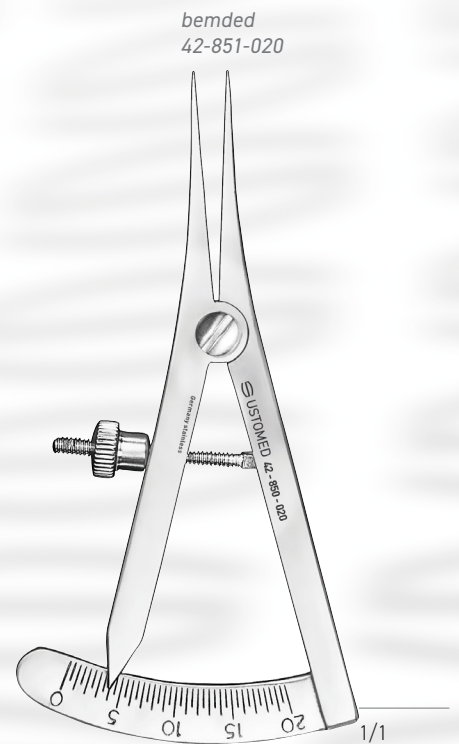

1/1

CASTROVIEJO
Caliper
42-850-020
85mm

08

Suction Tubes and Measuring Instruments

SUCTION TUBE

METAL

39-517-002
180mm, 2mm diameter

39-517-003
180mm, 3mm diameter

39-517-004
180mm, 4mm diameter

39-517-005
180mm, 5mm diameter



09

SINUS CURETTES

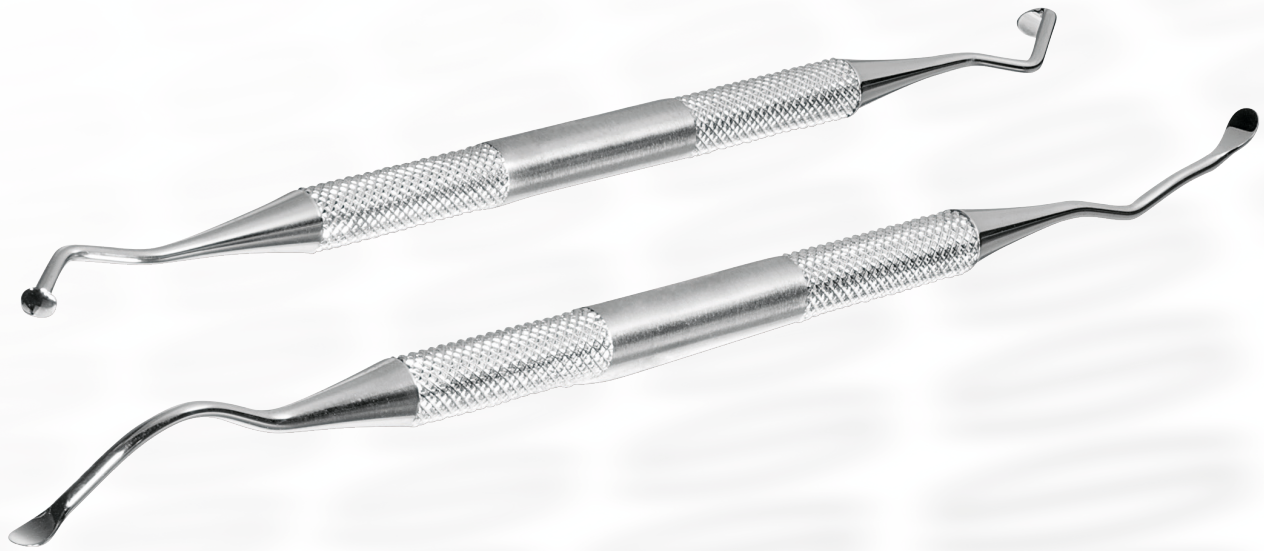

09

Sinus Currettes



1/1
HOTZ
Sinus Curette Fig. 1
46-695-001
185mm



1/1
HOTZ
Sinus Curette Fig. 2
46-695-002
190mm



1/1
KHOURY
Sinus Curette Fig.3
46-695-003
180mm



1/1

KHOURY
Sinus Curette Fig. 4
46-695-004
180mm



1/1

HOTZ
Sinus Curette Fig. 5
46-695-005
205mm



1/1

NENTWIG
Sinus Curette Fig. 1
46-699-001
Usto-Soft-Grip
180mm

09

Sinus Curettes



NENTWIG
Sinus Curette Fig. 2

46-699-002
Usto-Soft-Grip
190mm



NENTWIG
Sinus Curette Fig. 3

46-699-003
Usto-Soft-Grip
190mm



NENTWIG
Sinus Curette Fig. 4

46-699-004
Usto-Soft-Grip
190mm

10

AUGMENTATION



10

Augmentation

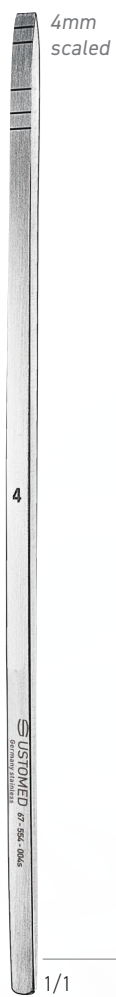

MINI-LAMBOTTE
Osteotome

67-554-004 S

130mm



MINI-LAMBOTTE
Osteotome

67-554-006 S

130mm



MINI-LAMBOTTE
Osteotome

67-554-008 S

130mm



MINI-LAMBOTTE
Osteotome
67-555-004 S

130mm



MINI-LAMBOTTE
Osteotome
67-555-006 S

130mm

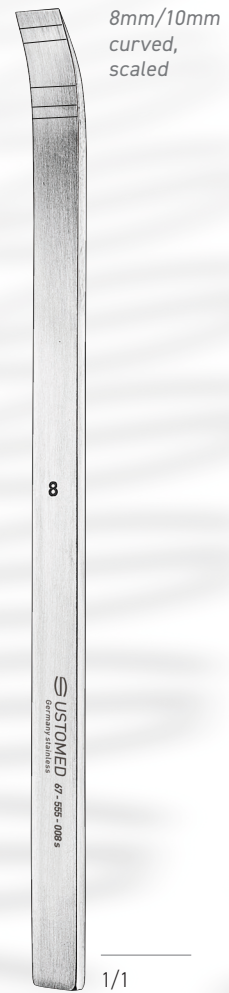

MINI-LAMBOTTE
Osteotome
67-555-008 S
67-555-010 S

130mm

10

Augmentation

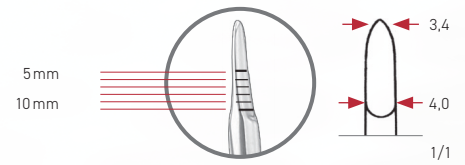
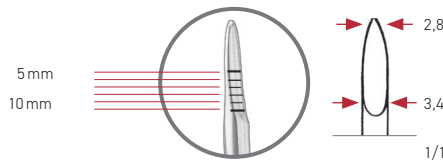
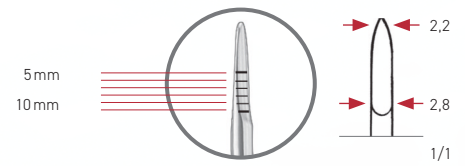
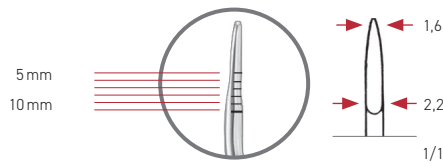
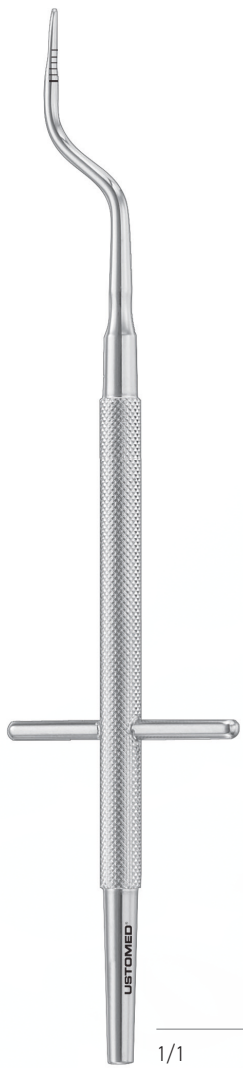

Condensing: preparation of the implant site when bone structure is compromised

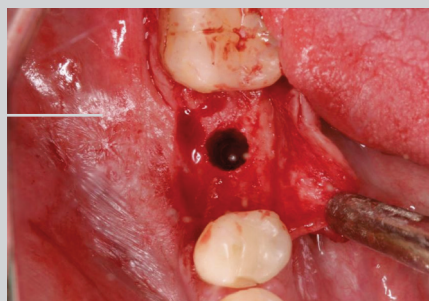

NENTWIG
Bone Spreader Set, bayonet
67-559-444
Set incl. 4 instruments
175mm

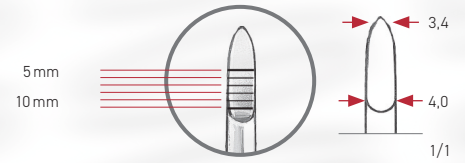
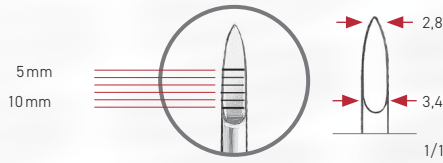
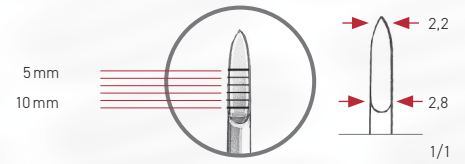
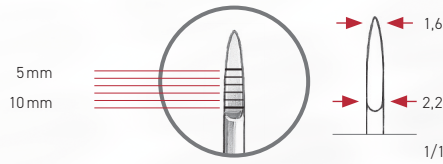

Localized spreading of the narrow ridge

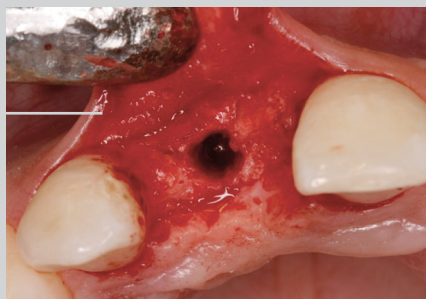
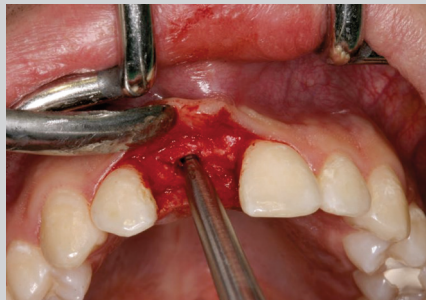

NENTWIG
Bone Spreader Set, straight
67-558-444
Set incl. 4 instruments
175mm

10

Augmentation

INFO

exchangeable
teflon inlays



1/1

Mallet

67-636-210

185mm, 210g



1/1

Mallet

67-660-150

165mm, 150g



1/1

NENTWIG
Mallet

67-638-300

200mm, 240g



1/1

OMBREDANNE
Mallet

67-670-240

260mm, 720g

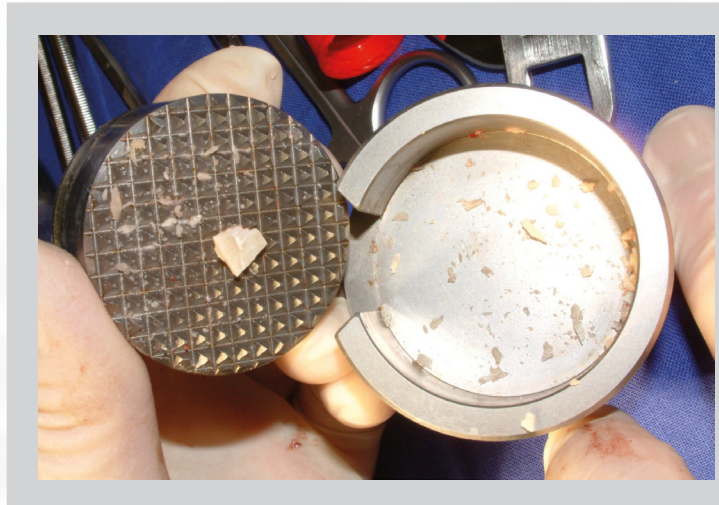

Photo Copyright Dr. Ponte



1/1

USTOMED
Bone Crusher

67-680-000

round

10

Augmentation

USTOMED Bone Mill



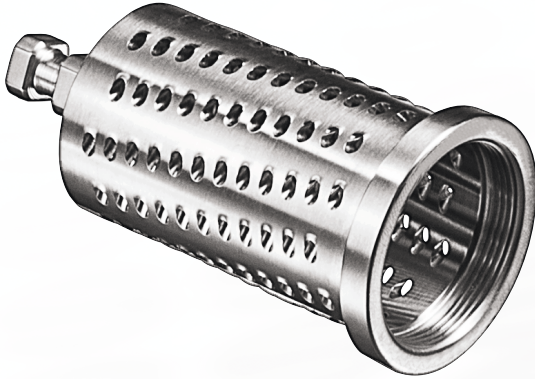

Cutting Cylinder S
67-682-012



Cutting Cylinder M
67-682-013

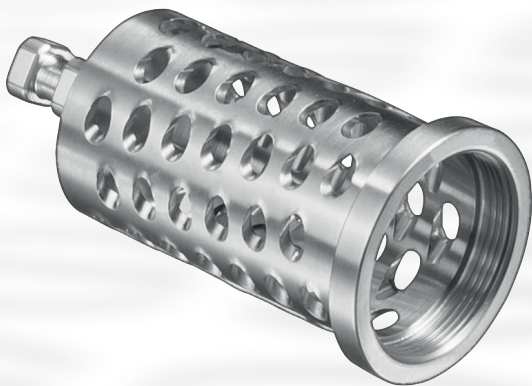

Cutting Cylinder L
67-682-014



Collection Container
67-682-020

10

Augmentation



Bone-Grinder Forceps

67-678-170

170mm



USTOMED
Combination Instrument
67-691-003

200mm



DEGIDI
Plugger
67-693-012

190mm



DEGIDI
Plugger
67-693-034

190mm

10

Augmentation

Trephine-Burs for Contra-Angle Handpieces

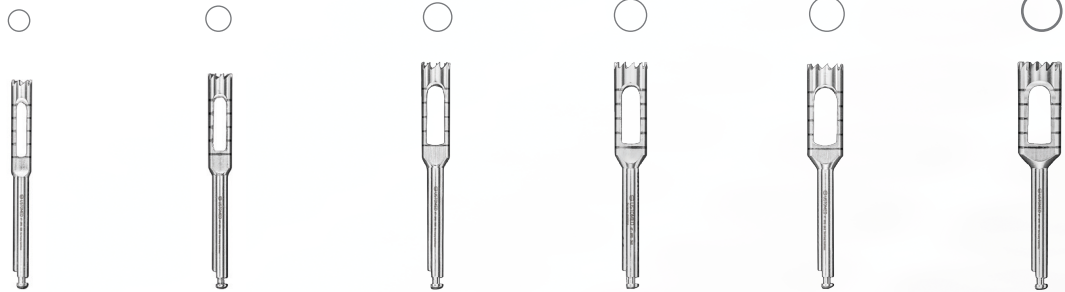
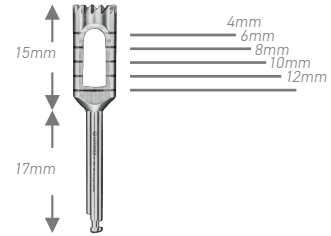

	67-890-025	67-890-030	67-890-035	67-890-040	67-890-045	67-890-050
Outer \varnothing	3,0	3,5	4,0	4,5	5,0	6,0
Inner \varnothing	2,5	3,0	3,5	4,0	4,5	5,0

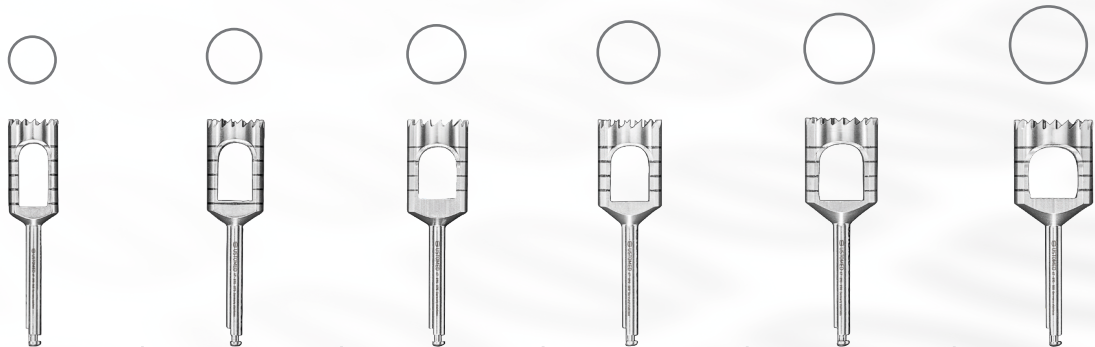

	67-890-060	67-890-070	67-890-075	67-890-080	67-890-090	67-890-100
Outer \varnothing	7,0	8,0	8,5	9,0	10,0	11,0
Inner \varnothing	6,0	7,0	7,5	8,0	9,0	10,0

Trephine-Burs for Handpieces

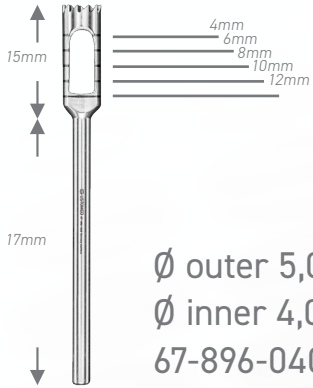

Ø outer 5,0mm
 Ø inner 4,0mm
 67-896-040



Outer Ø 7,0mm
 Inner Ø 6,0mm
 67-896-060



Outer Ø 11,0mm
 Inner Ø 10,0mm
 67-896-100

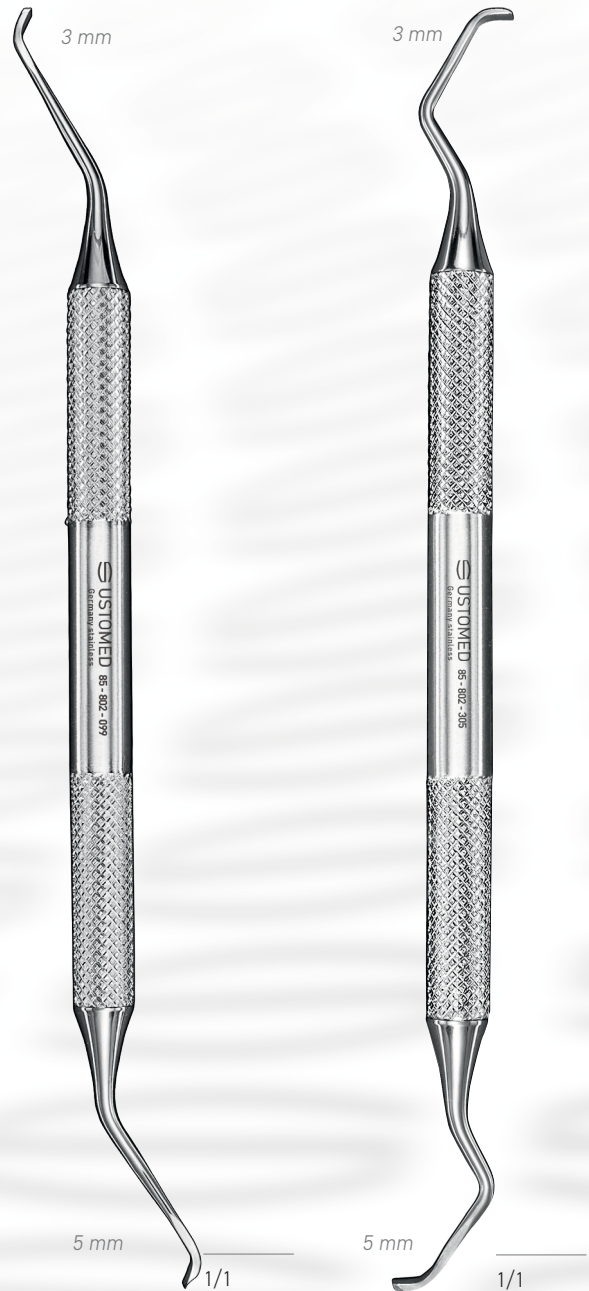

BONE SCRAPER

170mm
 3mm und 5mm width

85-802-099

85-802-305

10

Augmentation



MICROSS
Bone Scraper
single-use

85-802-005

160mm

straight



curved



SAFESCRAPER
Bone Scraper
single-use

85-802-001 straight

85-802-002 curved

150mm

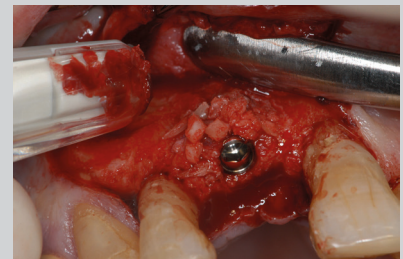
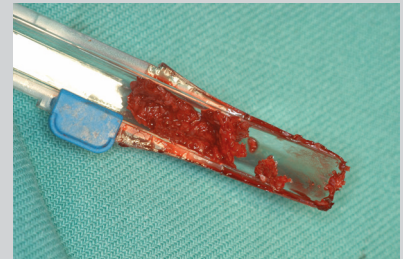
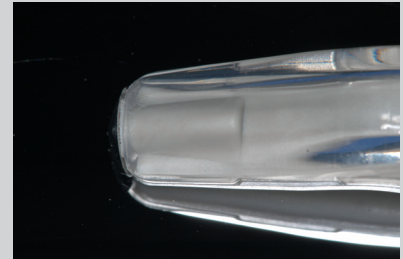

Photos Copyright Dr. Ponte

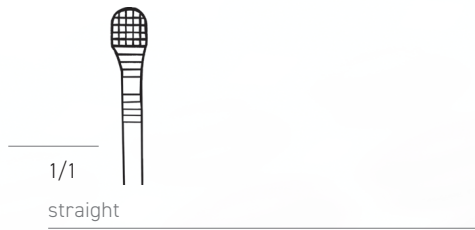

NENTWIG
Bone-Fixation Forceps
31-196-000

130mm

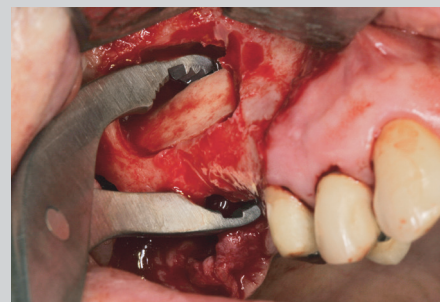
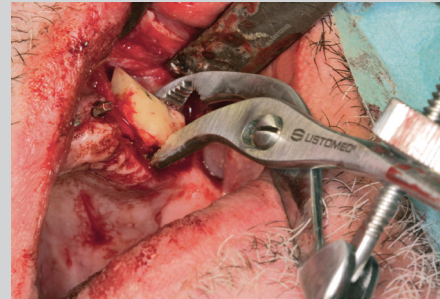

USTOMED Titan-Pin-Set



Titan-Pins

Applicator

- Single-piece instruments to collect the pins from the holding tray therefore the twisting of the working tip during the operation is excluded.
- Very ergonomical and comfortable Grip for a safe operation of the Titan-Pins

Holding Tray

- Functional Design
- safe and easy to operate with single hand principle
- Box can contain up to 15 Titan-Pins

USTOMED Titan-Pin-Set

Titan-Pins for the fixation of membranes.



Pin-Set complete
68-780-018

USTOMED T-Fix Micro-Membrane-Screws

68-115-004 (pack of 10pcs.)

4mm length, 1,5mm diameter, conical thread,
self-drilling, self-cutting

possible collection box for screws (68-720-002)



3/1

10

Augmentation

USTOMED Bone-Fixation Set



Contents:**68-780-016****Bone-Fixation Set -TITAN-:**

68-720-002	Box for Micro-Screws and Accessories
68-740-002	Screw Driver, 11cm
68-760-102	Blade, cross, self-retaining, 60 mm
*	1x Pilot Bur \varnothing 1,0mm or \varnothing 1,2mm
*	1x Pack Titanium-Micro-Screws of choice

68-780-010**Bone-Fixation Set -STEEL-:**

68-720-002	Box for Micro-Screws and Accessories
68-740-002	Screw Driver, 11cm
68-508-014	1x Pilot Bur \varnothing 0,8mm
*	1x Pack Steel-Micro-Screws of choice

Micro Screws (10 pcs. per Pack):

68-112-006	Titanium, \varnothing 1,2mm, 6mm length, cross
68-112-008	Titanium, \varnothing 1,2mm, 8mm length, cross
68-112-011	Titanium, \varnothing 1,2mm, 11mm length, cross
68-112-013	Titanium, \varnothing 1,2mm, 13mm length, cross
68-114-006	Titanium, \varnothing 1,4mm, 6mm length, cross
68-114-008	Titanium, \varnothing 1,4mm, 8mm length, cross
68-114-011	Titanium, \varnothing 1,4mm, 11mm length, cross
68-114-013	Titanium, \varnothing 1,4mm, 13mm length, cross
68-110-008 S	Implant-Steel Alloy, \varnothing 1,0mm, 8mm length, cross
68-110-011 S	Implant-Steel Alloy, \varnothing 1,0mm, 11mm length, cross
68-110-013 S	Implant-Steel Alloy, \varnothing 1,0mm, 13mm length, cross
68-115-004	Titanium, Membrane Screws \varnothing 1,5mm, 4mm length, conical threat, self-drilling, self-cutting

Pilot Burs:

68-508-014	\varnothing 0,8mm, 14mm length, for \varnothing 1,0mm screws, with depth scale
68-510-014	\varnothing 1,0mm, 14mm length, for \varnothing 1,2mm screws, with depth scale
68-512-014	\varnothing 1,2mm, 14mm length, for \varnothing 1,4mm screws, with depth scale
68-514-014	\varnothing 1,4mm, 14mm length, for \varnothing 1,6mm screws, with depth scale

Accessories:

68-720-002	Box for Micro-Screws and Accessories
68-740-002	Screw Driver, 11cm
68-860-008	Micro Titanium-Plates, 0,6mm, 8-hole
68-860-012	Micro Titanium-Plates, 0,6mm, 12-hole

10

Augmentation

Box for Micro Screws and Accessories

- Sophisticated and functional Design
- Integrated ruler for the exact determination of screw and graft lengths (removable)
- Newly-developed Material by Aerospace Engineering - THERMOSTABLE
- All parts are suitable for machine processing in the thermodisinfectors as well as for all conventional methods, thus corresponding to the latest „RKI - Guidelines“
- Collection tray for all Ustomed screw sizes- diameter (1,0 mm to 1,6 mm)

Screw Driver

- perfect handle length - therefore suitable for all hand sizes
- The ergonomic handle allows a comfortable and fatigue-free operation
- Self-holding mechanism for collecting screws with spring effect

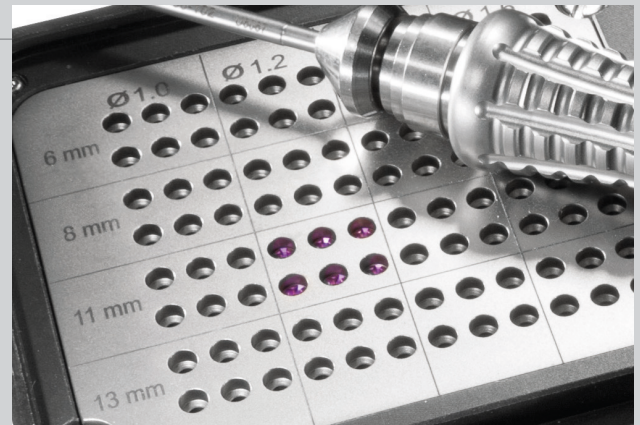



Foto: Dr. Jan Kielhorn



Innovative Geometry of the Micro Screws

- Precisely milled cross-slit screw head
- all screw types (1,0mm bis 1,4mm) are to be collected with the same blade
- Fast and safe collection of the self-holding micro screws
- Extreme friction between screw head and blade, prevents wear-and-tear
- Much easier removal of debris from the cross-slit (in comparison to inner four-edge or Torx)

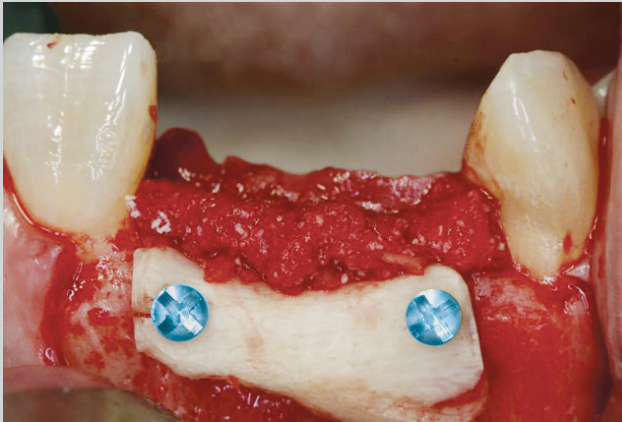

Foto: Dr. Stephan Beuer, M. Sc.



10

Augmentation

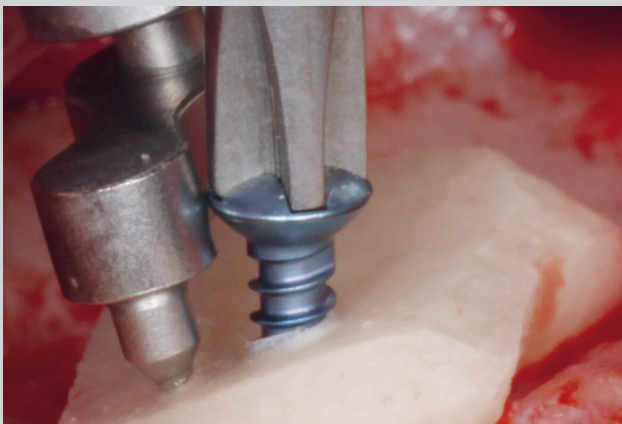
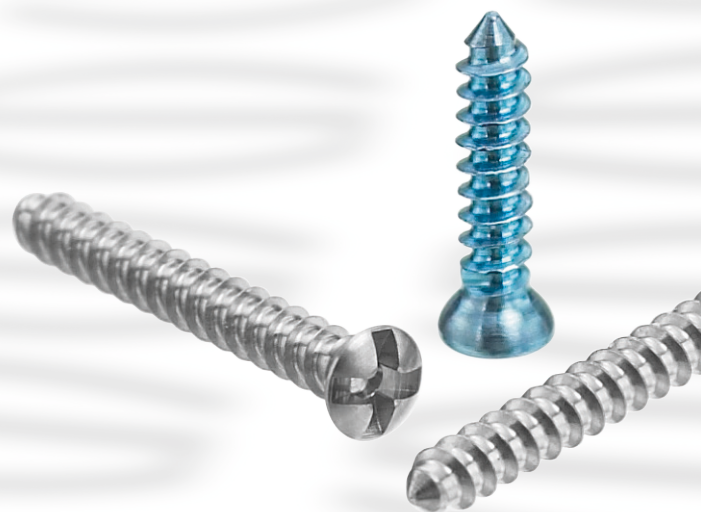
Titanium Micro Screws

- diameter: 1,2 mm / 1,4 mm
- length: 6 mm / 8 mm / 11 mm / 13 mm

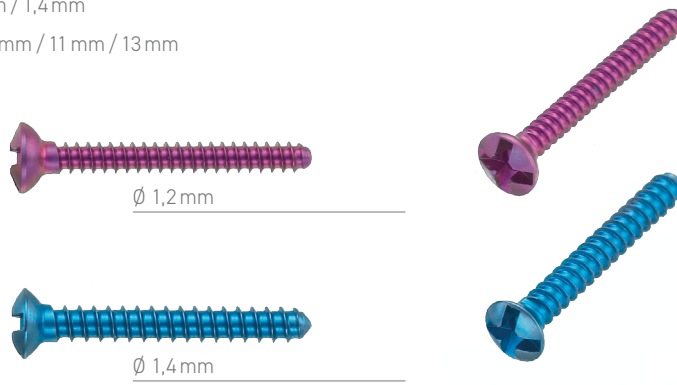

Implant-Steel Alloy Micro Screws

- diameter: 1,0 mm
- lengths: 8 mm / 11 mm / 13 mm
- perfectly suited for very small bone grafts and 3D-Augmentations
- special alloy material prevents Osseointegration and therefore a dramatically reduced danger of breaking the screws in comparison to titanium screws of similar lengths

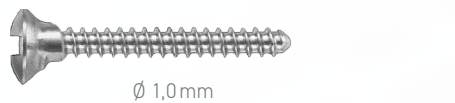

T-Fix Membrane screw

- conical thread
- length: 4 mm
- self-cutting/self-drilling, no pre-drilling
- perfect for applications in strong cortical bone
- for PTFE and titanium-reinforced membranes



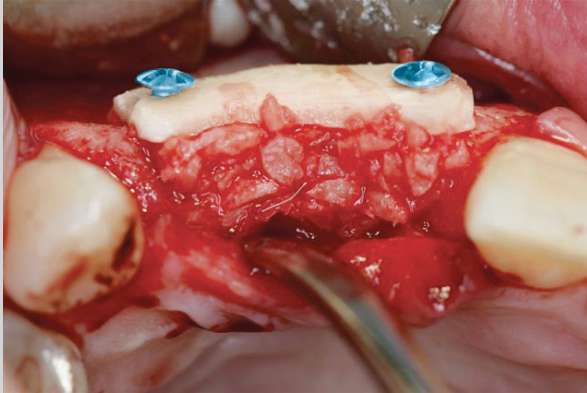

Dr. Jan Kielhorn

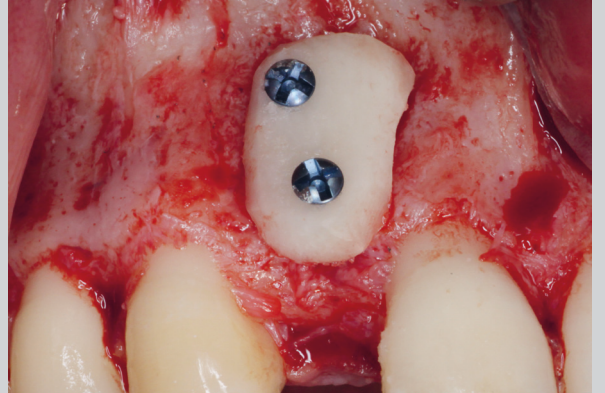

Photo: Dr. Stephan Beuer, M. Sc.

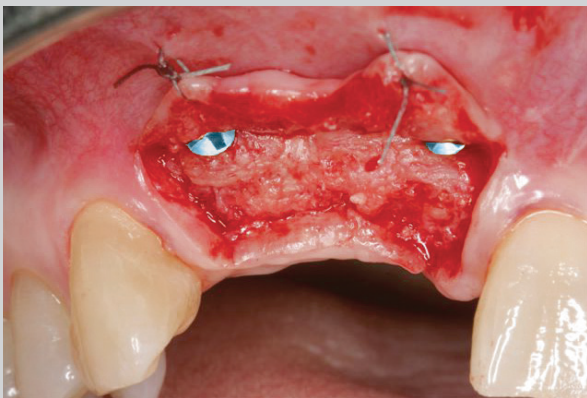

Photo: Dr. Jan Kielhorn

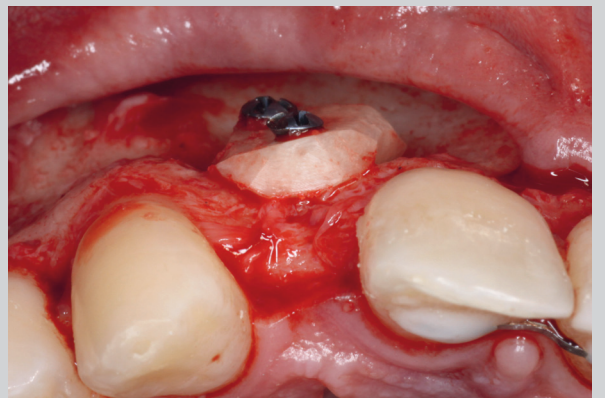

Photo: Dr. Stephan Beuer, M. Sc.

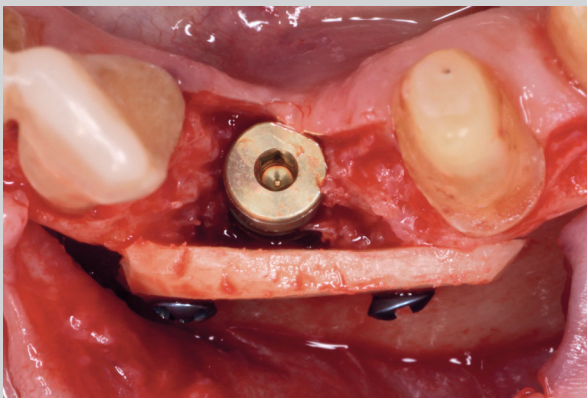

Photo: Dr. Stephan Beuer, M. Sc.

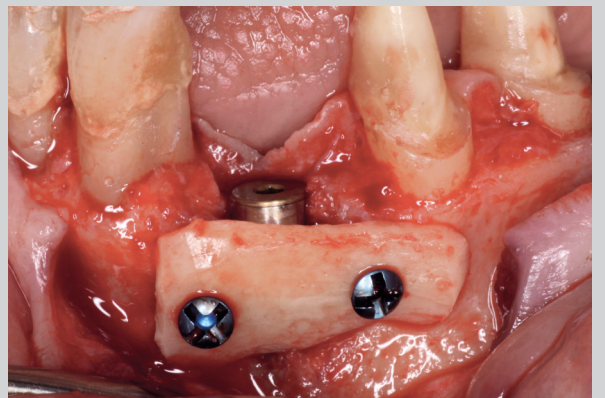

Photo: Dr. Stephan Beuer, M. Sc.

UMBRELLA-TECHNIQUE by Dr. Dr. Schlee



Implant-Steel Alloy

- diameter: 1,2mm
- lengths: 8 mm / 11 mm / 13mm
- screw head diameter: 5mm
- no Osseointegration

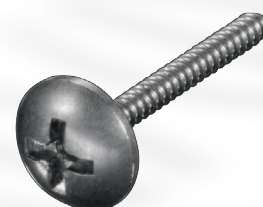
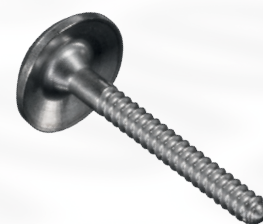

highly-magnified presentation

Bestandteile:

68-780-014	Umbrella-Technique-Set:
68-720-010	Box for Micro-Screws and Accessories
68-740-002	Screw Driver, 11cm
68-760-102	Blade, cross, self-retaining, 60 mm
68-510-014	Pilot Bur \varnothing 1,0mm
*	3x Umbrella Screw, of choice

Umbrella Screws (packed individually):

68-112-208 S	\varnothing 1,2mm, 8mm length
68-112-211 S	\varnothing 1,2mm, 11mm length
68-112-213 S	\varnothing 1,2mm, 13mm length

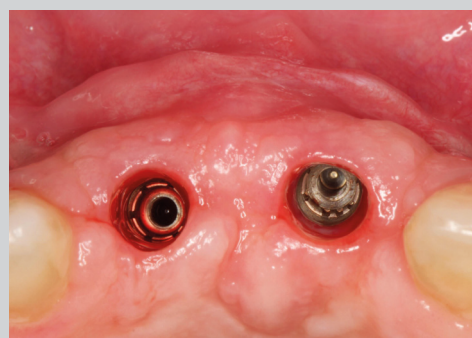
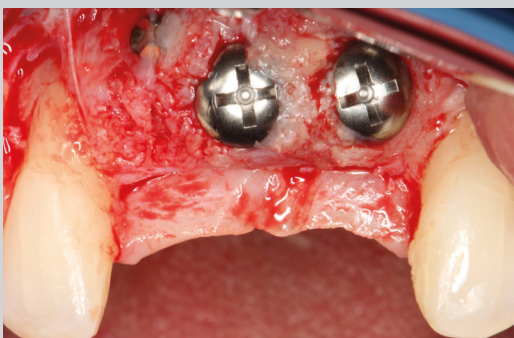
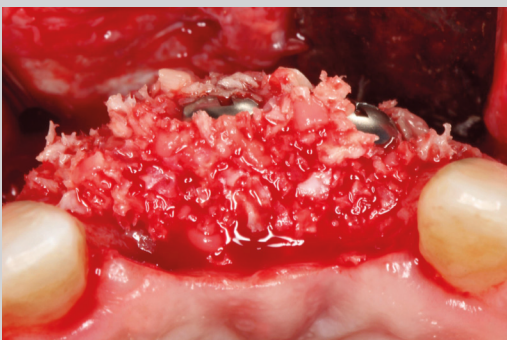
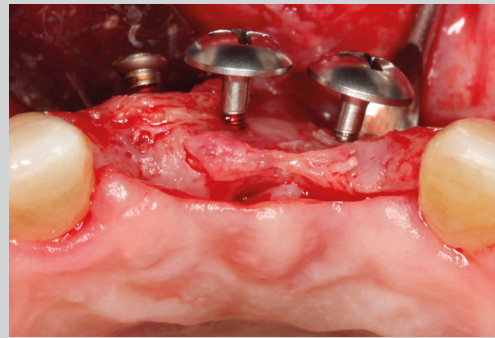

10

Augmentation



1/1

Luer
Bone Rongeur
31-379-150

150mm



1/1

FRIEDMAN
Bone Rongeur
31-321-140

140mm

11

ROOT ELEVATORS, LUXATORS AND DESMOTOMES



11

Root Elevators, Luxators and Desmotomes



BEIN
Root Elevator
83-100-002
straight
140mm



BEIN
Root Elevator
83-100-003
straight
140mm



BEIN
Root Elevator
83-100-004
straight
140mm



Bein
Root Elevator
83-100-005
straight
140mm



BEIN
Root Elevator
83-111-025
curved
140mm



BEIN
Root Elevator
83-111-035
curved
140mm

11

Root Elevators, Luxators and Desmotomes



BEIN
Root Elevator
83-111-045
curved
140mm



BEIN-LUXATOR
Luxator
83-120-003
delicate, straight
140mm



BEIN-LUXATOR
Luxator
83-120-004
delicate, straight
140mm



Bein-Luxator
Luxator
83-120-005
delicate, straight
140mm



BEIN-LUXATOR
Luxator
83-121-003
delikat, curved
140mm



BEIN-LUXATOR
Luxator
83-121-004
delikat, curved
140mm

11

Root Elevators, Luxators and Desmotomes



1/1

BEIN-LUXATOR
Luxator

83-121-005
delicate, curved
140mm



1/1

Desmotome

83-904-000
straight
145mm

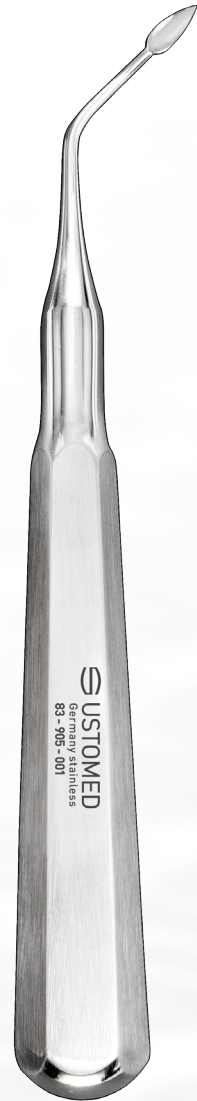

1/1

Desmotome

83-905-001
angled, right
140mm

83-905-002
angled, left
140mm

12

INSTRUMENT SETS



Scan to download
brochure

MUCOGINGIVAL PLASTIC SURGERY SET



90-180-000

- 05-803-180 I'Motion Micro-Scissors, 18cm, curved
- 09-280-180 I'Motion Micro-Tweezers, Cooley, 18cm, curved
- 20-753-180 I'Motion Micro-Needle Holder, 18cm, curved, TC (20-752-180 - straight Version)
- 02-038-140 Micro-Scalpel Holder, 14cm, anat.-shaped
- 10-871-160 Suture Forceps, 16cm, with open eye-tips
- 85-691-115 Univ. North Carolina Perio Probe
- 85-814-175 Papilla Elevator, Mod. Z, 17,5cm
- 85-818-001 Kasaj, Tunneling Knife 20cm, posterior
- 85-818-002 Kasaj, Tunneling Knife, 19cm, anterior
- 85-818-175 Tunneling Knife, 19cm curved
- 90-714-000 Ustomed Washing Basket

12

Instrument Sets

NENTWIG SURGICAL SETS



Scan to download
brochure

90-120-000 BASIC IMPLANTOLOGY SET

03-081-145 SC	Metzenbaum-Delikat, Dissecting Scissors, 14,5cm, curved, Super Cut
03-440-140 SC	Joseph, Suture/Gum Scissors, 14cm, straight, Super Cut
08-036-160	Dissecting Forceps, 16cm straight, cross-serrated
08-235-160	Tissue Forceps, 16cm, straight 1x2 teeth, very delicate
10-825-150	College modified Tweezers, 15cm, strong pattern
20-470-170	Lichtenberg Needle Holder, 17cm TC <i>(alternatively: 20-164-150 - Crile-Wood Needle Holder, 15cm, TC)</i>
24-161-002	Middeldorpf Cheek retractor, 22cm, Fig. 2
24-165-150	Cheek Retractor, 15cm, s.s. wire
24-187-190	Ustomed Universal Vestibule Retractor, 19cm, straight
27-717-175	Periosteal Elevator, 17,5cm, double-ended, curved
42-652-034	Bowman Antrum Probe, ball points, size 3/4
67-559-444	Original Nentwig Bone Spreading Set, 4 pcs., bajonet, 17,5cm scaled <i>(alternatively: 67-558-444 - Nentwig Bone Spreading Set, 4pcs., straight, 17,5cm, scaled)</i>
67-797-086	Lucas Bone Curette, 17cm, double-ended, size 86
67-903-000	Original Nentwig Fixation/Holding Instrument for Bone Reamer, bajonet, 15,5cm <i>(alternatively: 67-903-000 - Nentwig BFixation/Holding Instrument for Bone Reamer, straight)</i>
85-816-175	Papillae raspatory, Mod. B, fine, 17,5cm
90-714-000	Ustomed Washing Basket 270x170x35, FlexiKit, DIN

90-150-000 BONE AUGMENTATION SET

24-169-004	Langenbeck Retractor, size 4, 21cm, 40x11mm
24-191-230	Original Nentwig Zygomatic Retractor, 23cm
31-377-150	Luer Bone Rongeur, 15cm, curved, narrow
67-554-004 S	Mini-Lambotte Osteotome, 13cm, 4mm width, straight, scaled
67-554-008 S	Mini-Lambotte Osteotome, 13cm, 8mm width, straight, scaled
24-193-014	Original Nentwig Special Retractor, 24cm, 14mm width, right maxilla, left mandible
24-195-014	Original Nentwig Special Retractor, 24cm, 14mm width, left maxilla, right mandible
31-196-000	Original Nentwig Bone Holding/Fixation Forceps, straight, 13cm <i>(alternatively: 31-197-001 - curved right or 31-197-002 - curved left)</i>
67-638-300	Original Nentwig Mallet, 20cm, 300g
90-714-000	Ustomed Washing Basket 270x170x35, FlexiKit, DIN

13

CONTAINER SYSTEMS AND WASH TRAYS

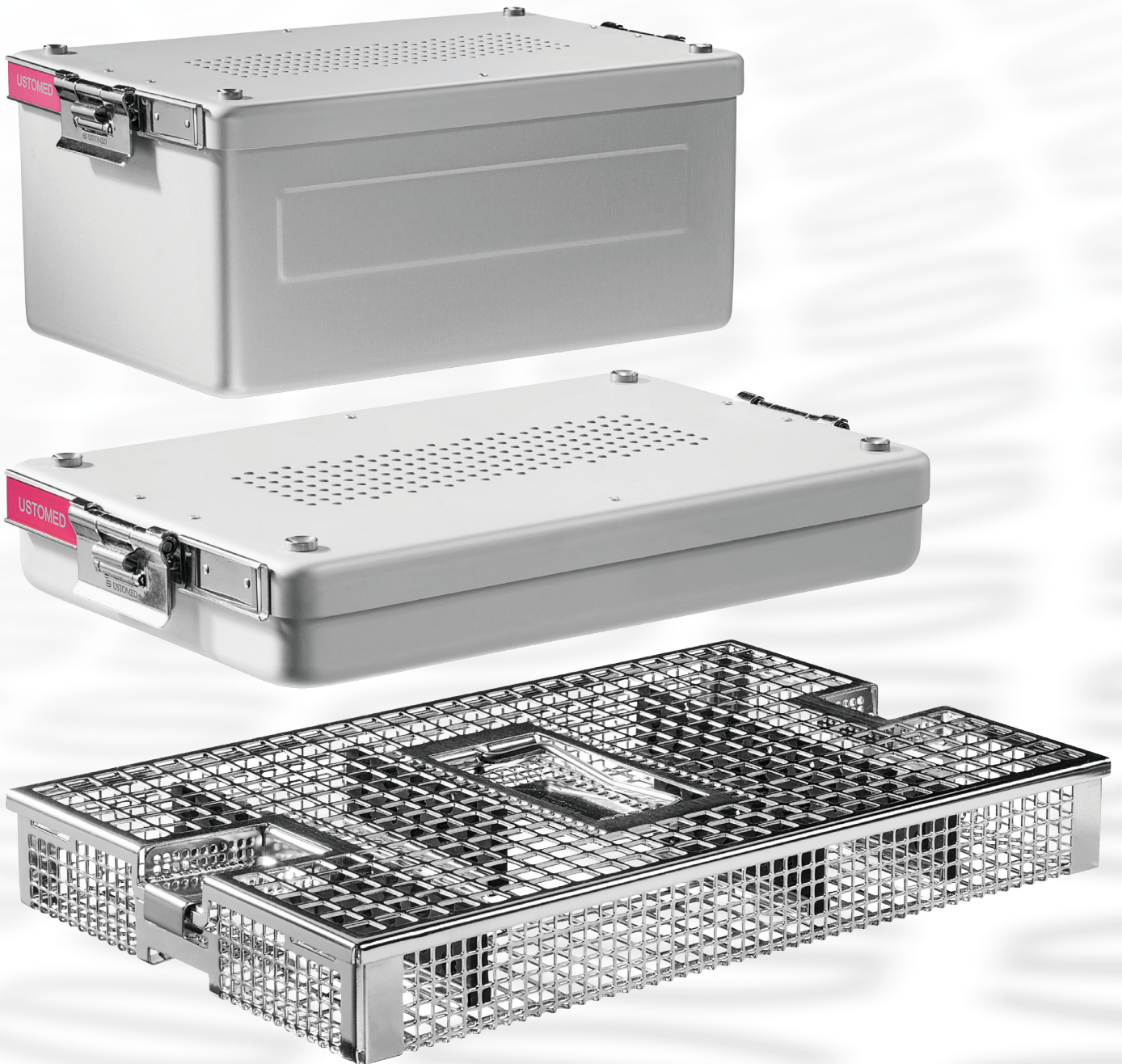

13

Container Systems and Wash Trays



Sterilization-Container
90-618-040
315 x 190 x 40mm



Sterilization-Container
90-618-065
315 x 190 x 65mm



Sterilization-Container
90-618-130
315 x 190 x 130mm



Ustomed
Teflon-Filter
90-642-002

Marking Plates,
including labeling



90-650-000 red



90-650-001 blue



90-650-002 green



90-650-003 yellow



90-650-004 black



90-650-005 silver



90-650-007 magenta



90-650-008 orange



Plate Holder
90-652-000



Seals
90-665-100
(pack contains 100 pcs.)



Marking Plate, HIBC, (Data Matrix)
90-654-000
or
Marking Plate, HIBC,
Code 128 (Barcode)
90-656-000

13

Container Systems and Wash Trays



Sterilization-Container
90-626-040
315 x 190 x 40mm



Sterilization-Container
90-626-065
315 x 190 x 65mm



Sterilization-Container
(Half-Size)
90-628-040
195 x 145 x 40mm



Sterilization-Container
(Half-Size)
90-628-065
195 x 145 x 65mm

DENTAL STERILIZATION-CONTAINER SYSTEM WITH SAFETY-FILTER

Ustomed's answer to consistently increasing demands for risk minimization, environmental protection and handling comfort, is the newly-developed Easy-Stop System.

The filterless mechanism stops microorganisms even more effectively than conventional filter systems and can be re-used as often as you like. There is no need for consumable purchasing.

To open or close, one handling step is enough:

Simply, press the lid down, and turn!



THE ADVANTAGES SPEAK FOR THEMSELVES:

- The unique lid is almost indestructible:
It is precision-milled from a solid block of aluminum. That way, the lid stays in shape and can withstand the daily office routines.
- Dirt- and germ-repellent
- Fast and residue-free drying during steam-sterilization
- High quality material for triple safety: adhere-free, pore-free and corrosion-free

INFO:

The two-piece aluminum insert in the lid serves as a germ barrier according to the principle of the „Pasteur Loops“. By forming a labyrinth of ring ribs, it therefore reliably separates microbes, germs and particles.

The meandering flow path achieves a decontamination rate of 99.997%

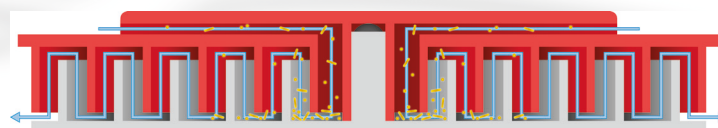

13

Container Systems and Wash Trays

Wash tray „Flexi-Kit“
with 5 silicon racks
270 x 170 x 35mm

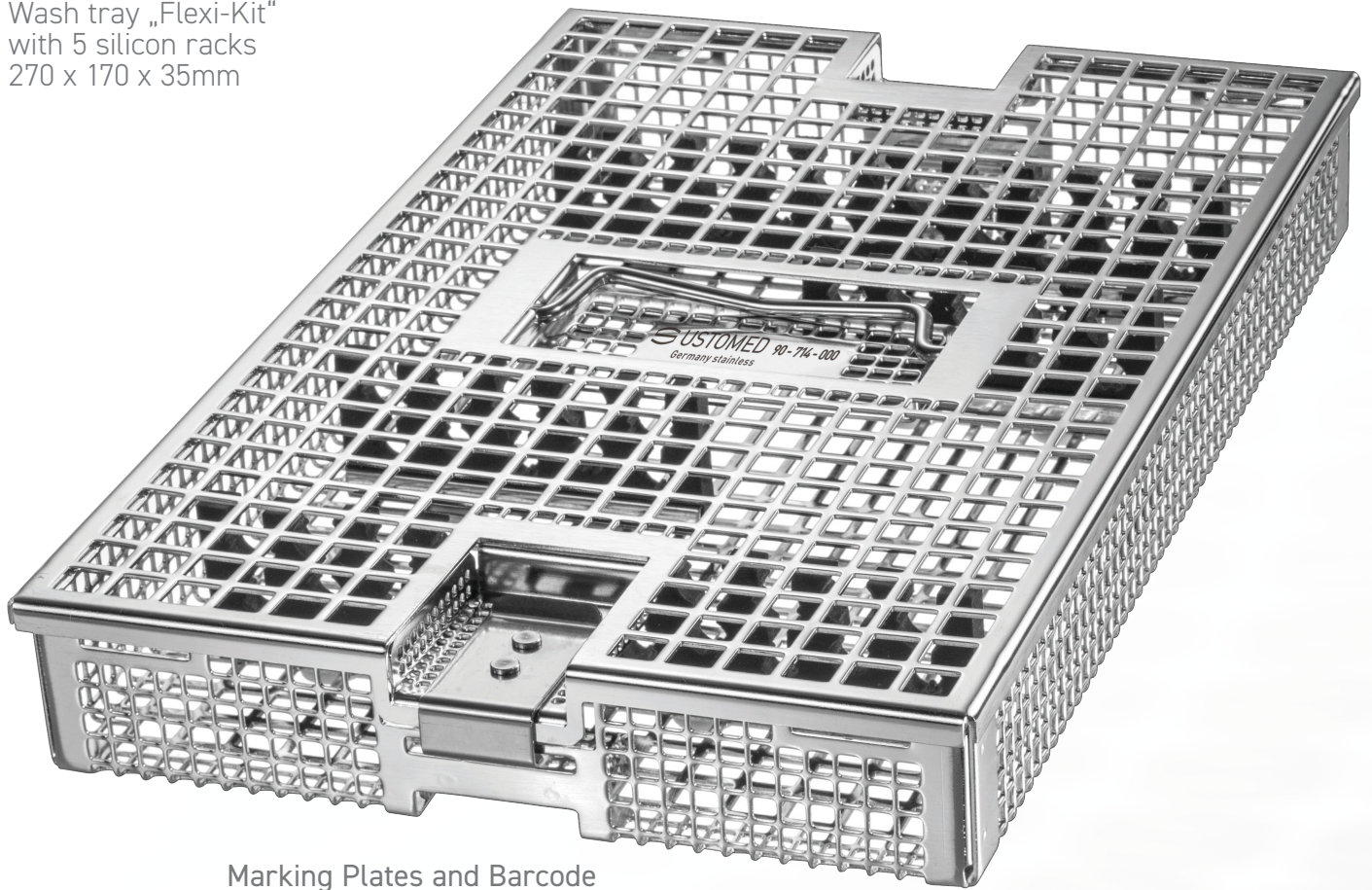

Marking Plates and Barcode
Plates (refer to page 105)

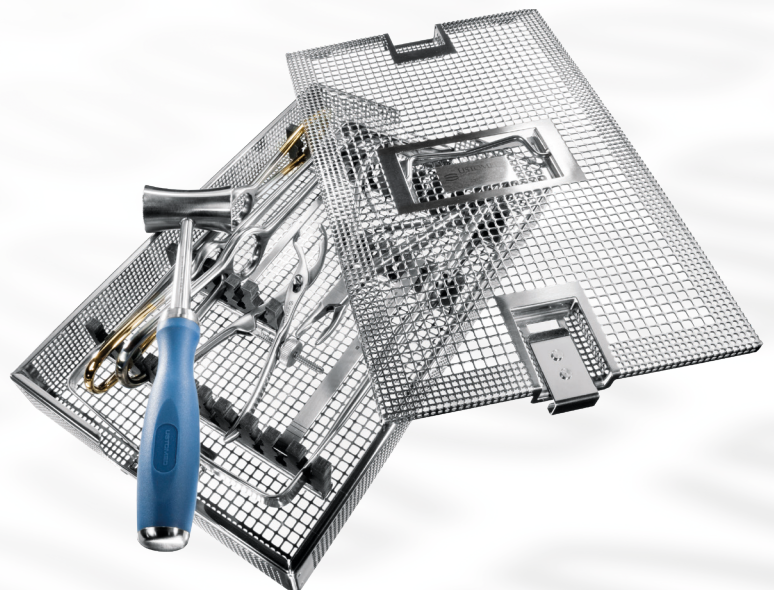
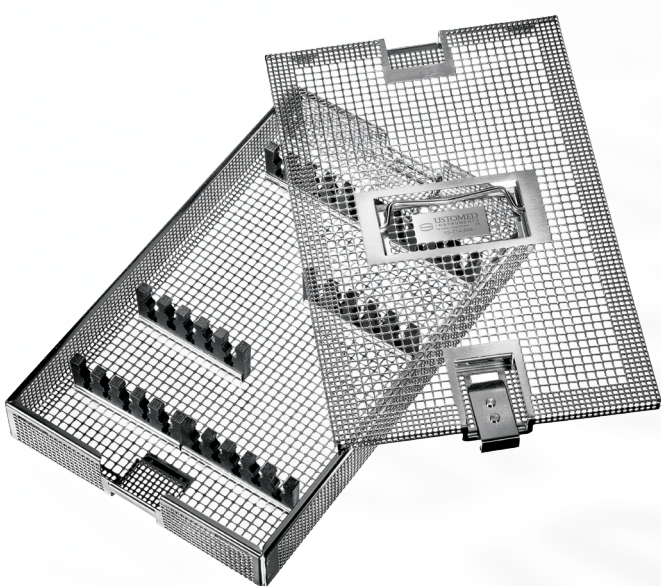

Packing Suggestion, Wash Tray is sold
without instruments



Sterilization and Collection Tray
for 4 instruments, half-size
90-340-004



Sterilization and Collection Tray
for 8 instruments, half-size
90-340-008

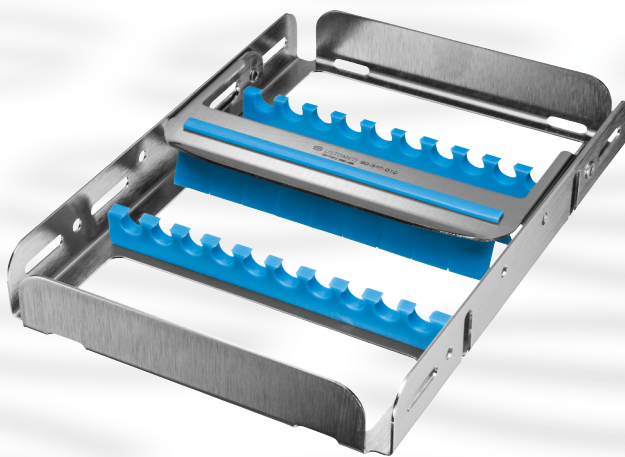

Sterilization and Collection Tray
for 10 instruments, half-size
90-340-010



USTOMED INSTRUMENTE
Ulrich Storz GmbH & Co. KG

Bischof-Sproll-Straße 2
78532 Tuttlingen / Germany

Manufacturer for Surgical and
Dental Instruments

Phone: +49 (0) 74 61 / 9 65 85 0
Fax: +49 (0) 74 61 / 9 65 85 65

info@ustomed.de
www.ustomed.de